

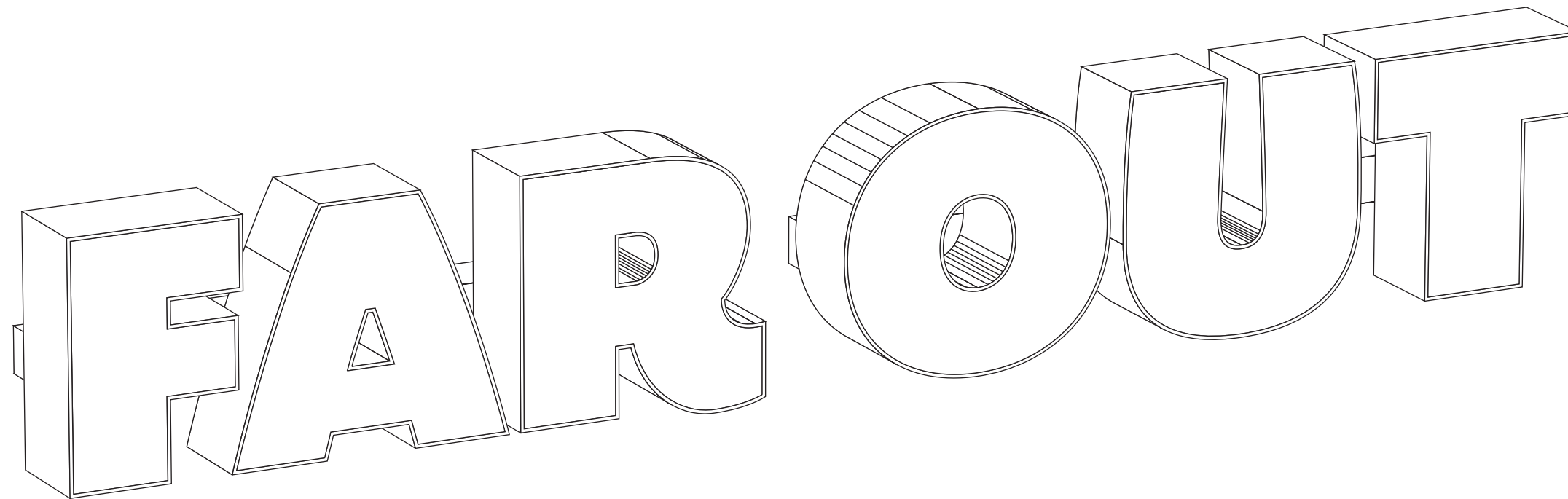

Main ID
 20" x 5-1/2" Deep Face Lit Channel Letters
 1" Trim Cap
 3/16" White 2447 Acrylic Face
 3M 3630-44- Orange Translucent Vinyl Applied to Face
 Returns & Trim Painted to Match PMS 172
 (1) 3-1/2" x 3-1/2" x 49" Raceway Painted to Match Building Facade
 (1) 3-1/2" x 3-1/2" x 54" Raceway Painted to Match Building Facade
 Power Supply Inside Raceway

Qty. (1)

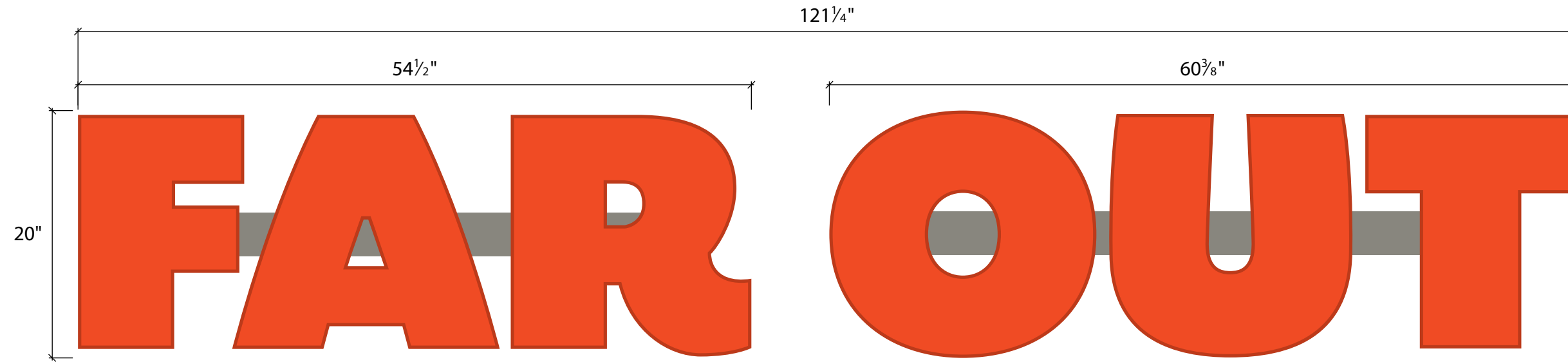

 ORANGE - PMS 172 = Avery 900 Translucent Orange

 To Match Building Facade

SRPSIGN
 CORPORATION
 236 PEARL STREET
 SOMERVILLE, MA 02145
 (617) 623-6222

PROJECT: FAR OUT ICE CREAM
 ADDRESS: 1930 BEACON STREET BOSTON, MA
 CLIENT: AUGUST RADBILL
 DRAWN BY: NICK MCGEE DATE: 03-10-26
 DESCRIPTION: EXTERIOR SIGNAGE
 FILE LOCATION: Clients\Far Out Ice Cream\Cleveland Circle\Far_Out_Exterior_cc_v1

PROPRIETARY NOTICE:
 THIS DRAWING SHEET AND CONTENTS
 HEREIN ARE THE PROPERTY OF SRP
 SIGN CORPORATION. USE OF THIS
 DRAWING'S CONTENTS OR DESIGN
 CONCEPTS FOR PURPOSES OTHER
 THAN ESTIMATING, DRAWING
 PREPARATION, AND/OR
 MANUFACTURING FOR SRP SIGN
 CORPORATION SHALL BE CAUSE FOR
 LEGAL RECOURSE BY SRP SIGN
 CORPORATION



Main ID
 20" x 5-1/2" Deep Face Lit Channel Letters
 1" Trim Cap
 3/16" White 2447 Acrylic Face
 3M 3630-44- Orange Translucent Vinyl Applied to Face
 Returns & Trim Painted to Match PMS 172
 (2) 3-1/2" x 3-1/2" x 49" Raceways Painted to Match Building Facade
 Power Supply Inside Raceway

Qty. (1)

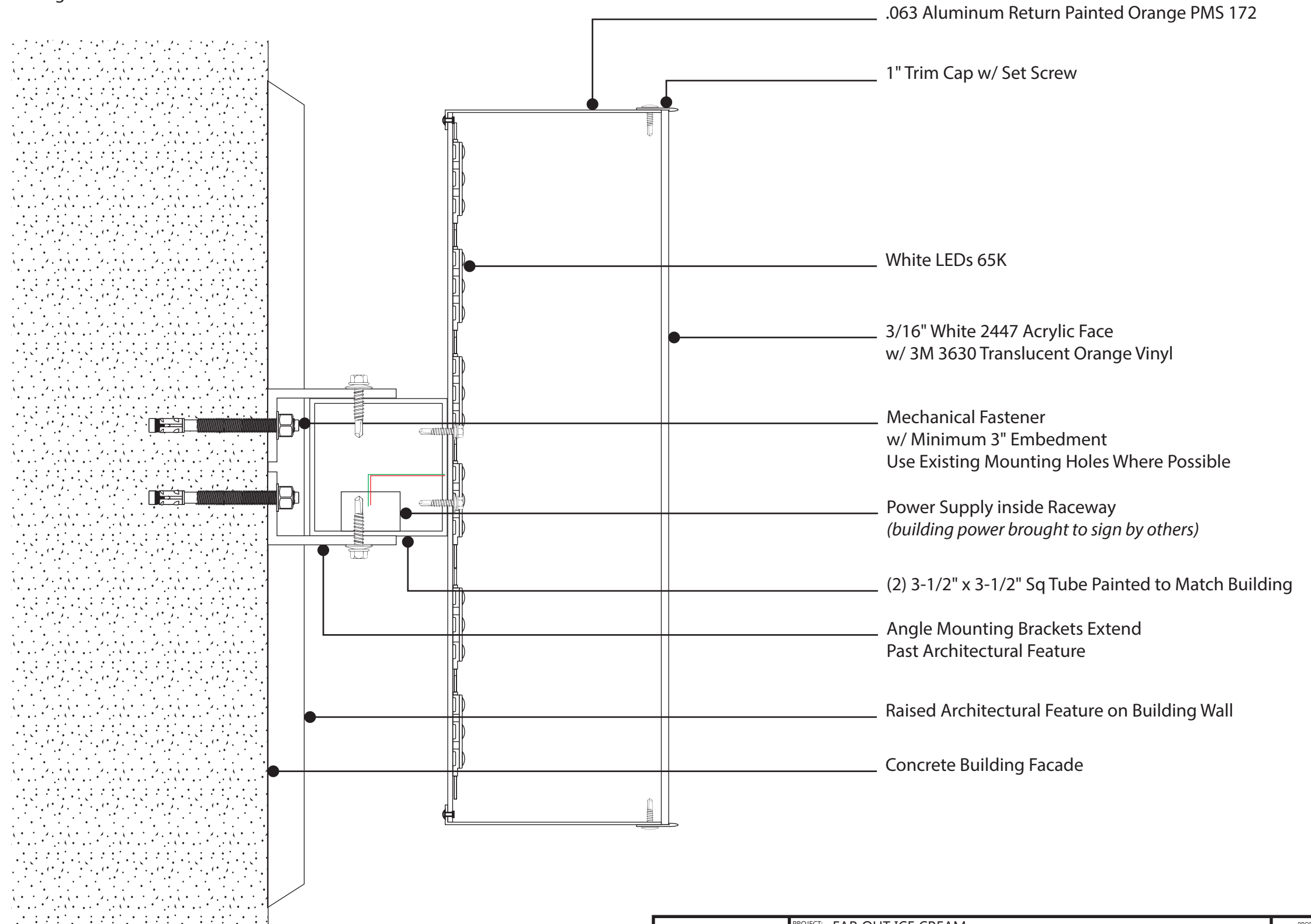

.063 Aluminum Return Painted Orange PMS 172

1" Trim Cap w/ Set Screw

White LEDs 65K

3/16" White 2447 Acrylic Face
w/ 3M 3630 Translucent Orange Vinyl

Mechanical Fastener
w/ Minimum 3" Embedment
Use Existing Mounting Holes Where Possible

Power Supply inside Raceway
(building power brought to sign by others)

(2) 3-1/2" x 3-1/2" Sq Tube Painted to Match Building

Angle Mounting Brackets Extend
Past Architectural Feature

Raised Architectural Feature on Building Wall

Concrete Building Facade

SRPSIGN
 CORPORATION
 236 PEARL STREET
 SOMERVILLE, MA 02145
 (617) 623-6222

PROJECT: FAR OUT ICE CREAM
 ADDRESS: 1930 BEACON STREET BOSTON, MA
 CLIENT: AUGUST RADBILL
 DRAWN BY: NICK MCGEE DATE: 03-10-26
 DESCRIPTION: EXTERIOR SIGNAGE
 FILE LOCATION: Clients\Far Out Ice Cream\Cleveland Circle\Far_Out_Exterior_cc_v1

PROPRIETARY NOTICE:
 THIS DRAWING SHEET AND CONTENTS
 HEREIN ARE THE PROPERTY OF SRP
 SIGN CORPORATION. USE OF THIS
 DRAWING'S CONTENTS OR DESIGN
 CONCEPTS FOR PURPOSES OTHER
 THAN ESTIMATING, DRAWING
 PREPARATION, AND/OR
 MANUFACTURING FOR SRP SIGN
 CORPORATION SHALL BE CAUSE FOR
 LEGAL RECOURSE BY SRP SIGN
 CORPORATION



Blade Sign
 29"H X 24"W x 2" Deep
 .080 Aluminum Face
 .063 Aluminum Returns
 3/8" Vertical Threaded Rod Support Arms w/ Spaces
 2-1/2" x 2-1/2" x 32" Horizontal Aluminum Sq Tube Support Arm
 6" x 6" x 3/8" Aluminum Mounting Plate
 1/4" Acrylic Tag Line Flush Mount w/ VHB
 3/8" Acrylic Logo & Name Flush Mount w/ VHB
 White Cut Vinyl "eye" Applied to Logo

Qty. (1)

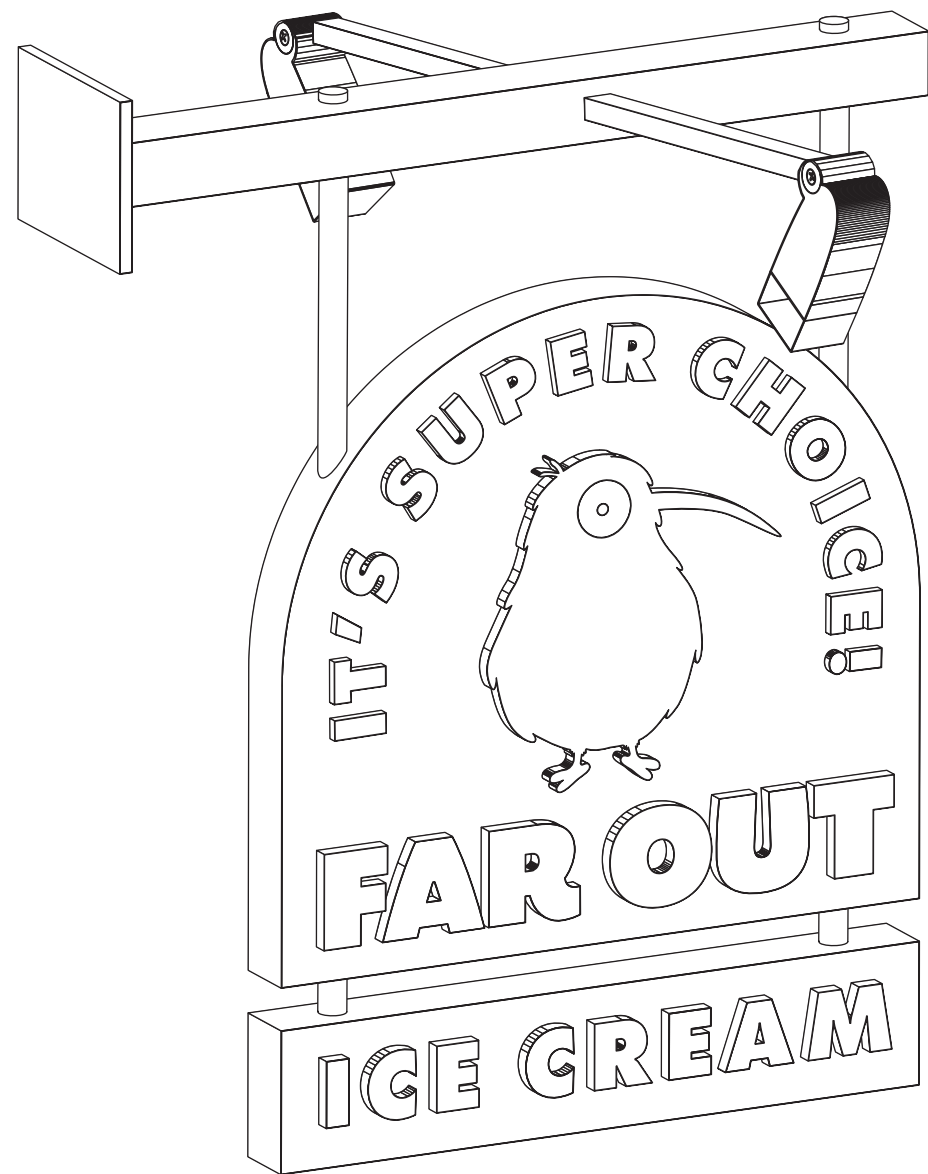

ORANGE - PMS 172

BEIGE - AKZO NOBEL 432B1

SRPSIGN
 CORPORATION
 236 PEARL STREET
 SOMERVILLE, MA 02145
 (617) 623-6222

PROJECT: FAR OUT ICE CREAM
 ADDRESS: 1930 BEACON STREET BOSTON, MA

CLIENT: AUGUST RADBILL

DRAWN BY: NICK MCGEE

DATE: 03-10-26

DESCRIPTION: EXTERIOR SIGNAGE

FILE LOCATION: Clients\Far Out Ice Cream\Cleveland Circle\Far_Out_Exterior_cc_v1

PROPRIETARY NOTICE:
 THIS DRAWING SHEET AND CONTENTS
 HEREIN ARE THE PROPERTY OF SRP
 SIGN CORPORATION. USE OF THIS
 DRAWING'S CONTENTS OR DESIGN
 CONCEPTS FOR PURPOSES OTHER
 THAN ESTIMATING, DRAWING
 PREPARATION, AND/OR
 MANUFACTURING FOR SRP SIGN
 CORPORATION SHALL BE CAUSE FOR
 LEGAL RECOURSE BY SRP SIGN
 CORPORATION



Blade Sign
 29"H X 24"W x 2" Deep
 .080 Aluminum Face
 .063 Aluminum Returns
 3/8" Vertical Threaded Rod Support Arms w/ Spaces
 2-1/2" x 2-1/2" x 32" Horizontal Aluminum Sq Tube Support Arm
 6" x 6" x 3/8" Aluminum Mounting Plate
 1/4" Acrylic Tag Line Flush Mount w/ VHB
 3/8" Acrylic Logo & Name Flush Mount w/ VHB
 White Cut Vinyl "eye" Applied to Logo

Qty. (1)

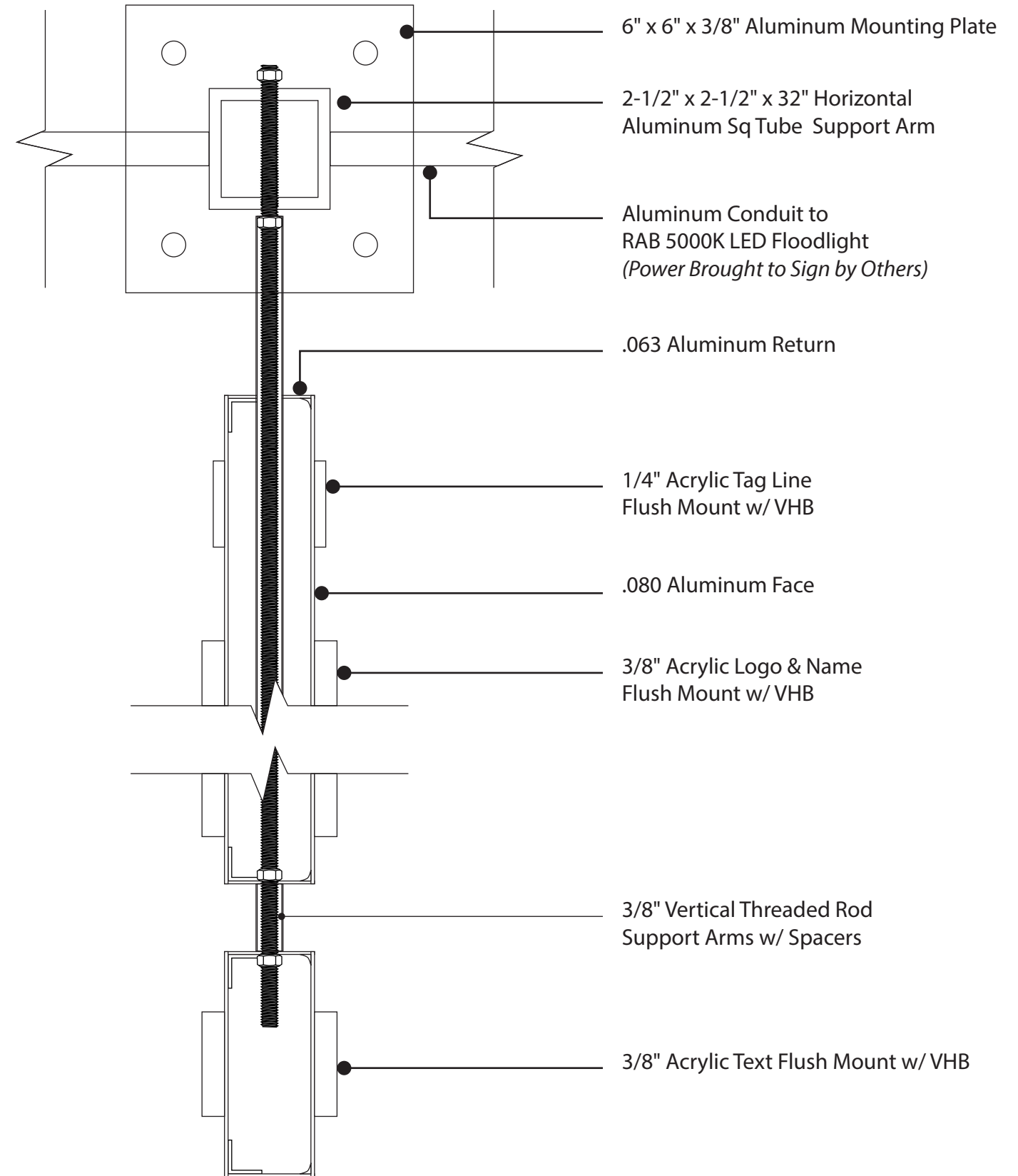
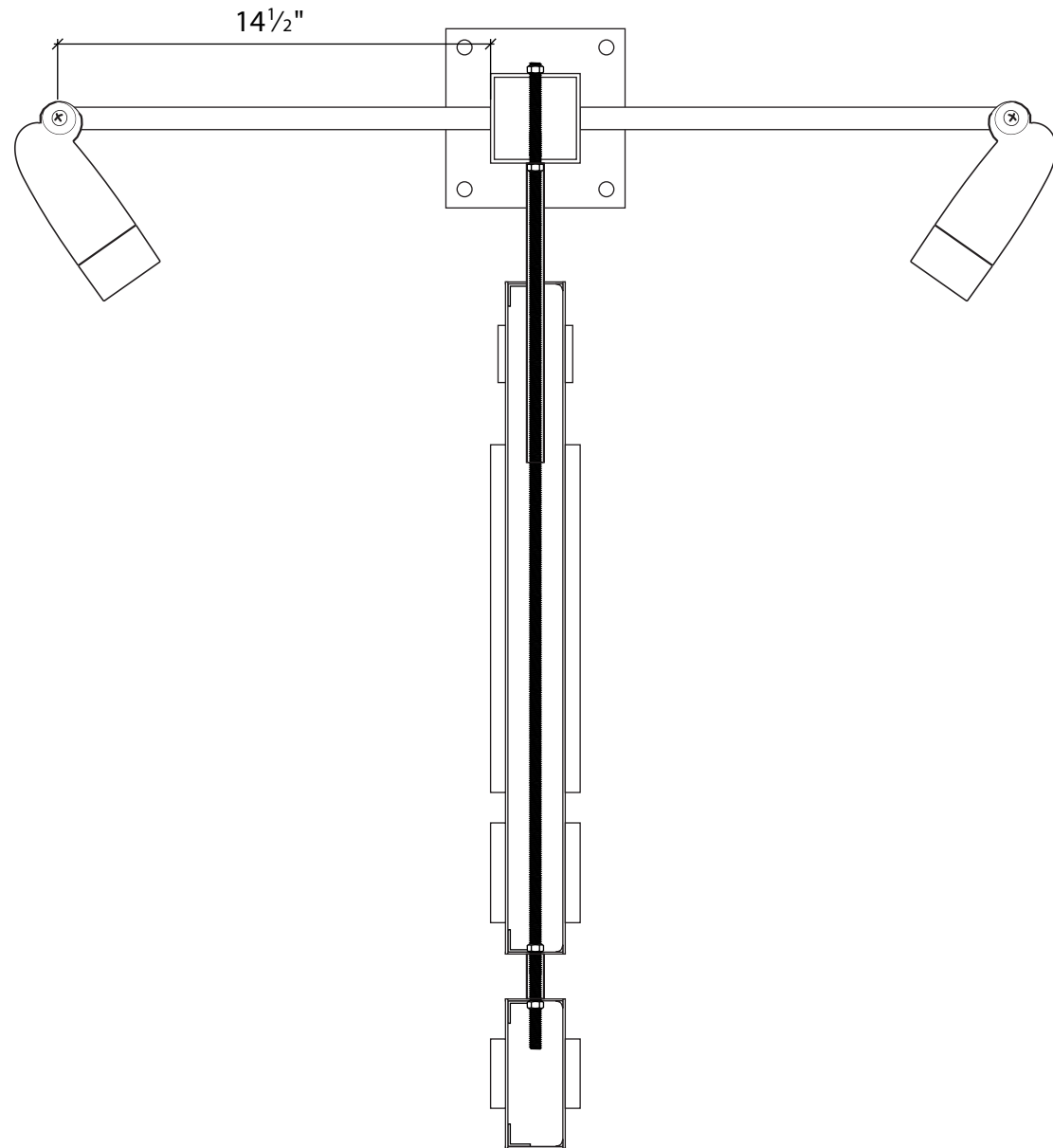

 236 PEARL STREET SOMERVILLE, MA 02145 (617) 623-6222	PROJECT: FAR OUT ICE CREAM ADDRESS: 1930 BEACON STREET BOSTON, MA	PROPRIETARY NOTICE: THIS DRAWING SHEET AND CONTENTS HEREIN ARE THE PROPERTY OF SRP SIGN CORPORATION. USE OF THIS DRAWING'S CONTENTS OR DESIGN CONCEPTS FOR PURPOSES OTHER THAN ESTIMATING, DRAWING PREPARATION, AND/OR MANUFACTURING FOR SRP SIGN CORPORATION SHALL BE CAUSE FOR LEGAL RECOURSE BY SRP SIGN CORPORATION	
	CLIENT: AUGUST RADBILL		
	DRAWN BY: NICK MCGEE DATE: 03-10-26		
	DESCRIPTION: EXTERIOR SIGNAGE		
	FILE LOCATION: Clients\Far Out Ice Cream\Cleveland Circle\Far_Out_Exterior_cc_v1		

Blade Sign
 29"H X 24"W x 2" Deep
 .080 Aluminum Face
 .063 Aluminum Returns
 3/8" Vertical Threaded Rod Support Arms w/ Spaces
 2-1/2" x 2-1/2" x 32" Horizontal Aluminum Sq Tube Support Arm
 6" x 6" x 3/8" Aluminum Mounting Plate
 1/4" Acrylic Tag Line Flush Mount w/ VHB
 3/8" Acrylic Logo & Name Flush Mount w/ VHB
 White Cut Vinyl "eye" Applied to Logo

Qty. (1)

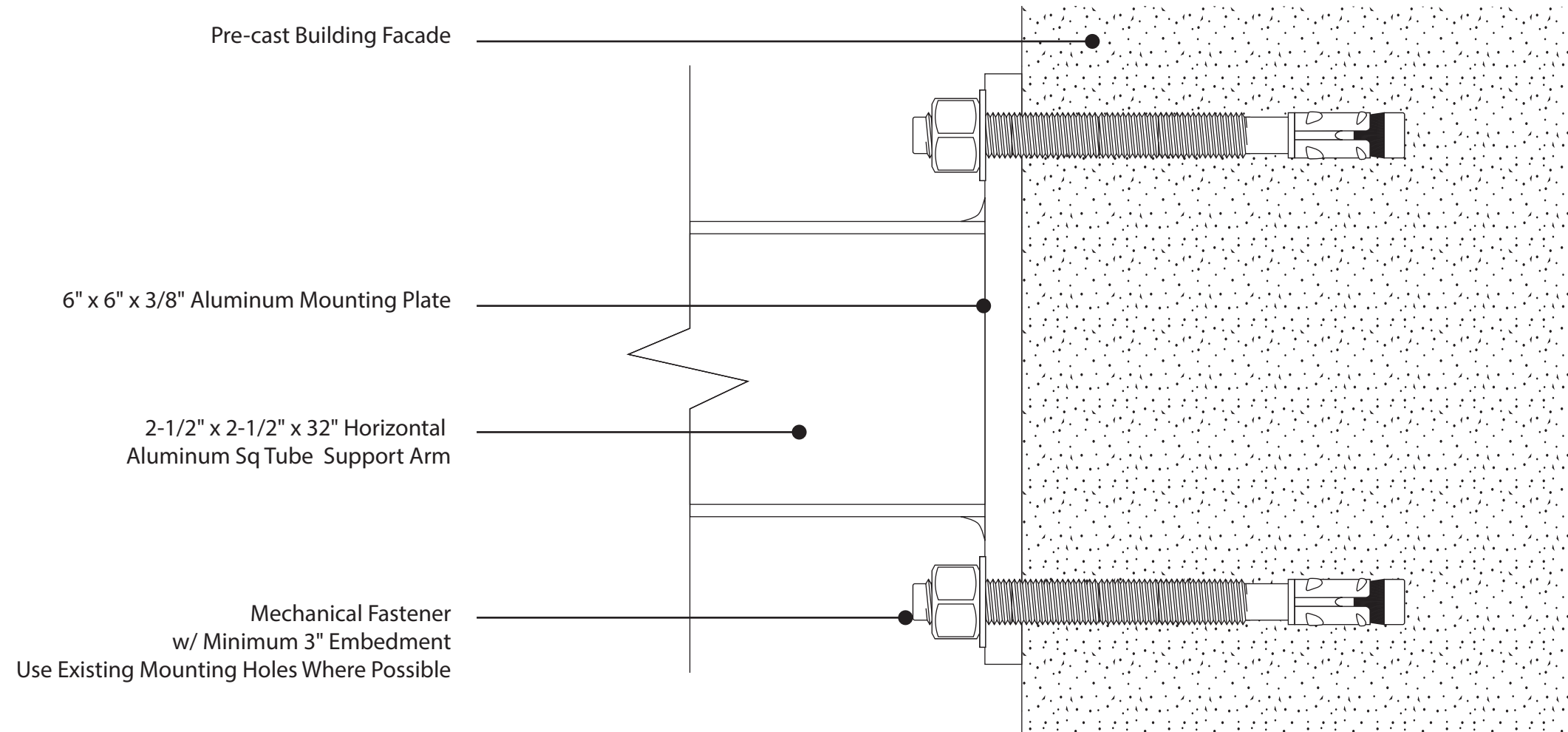

SRPSIGN CORPORATION 236 PEARL STREET SOMERVILLE, MA 02145 (617) 623-6222	PROJECT: FAR OUT ICE CREAM ADDRESS: 1930 BEACON STREET BOSTON, MA		PROPRIETARY NOTICE: THIS DRAWING SHEET AND CONTENTS HEREIN ARE THE PROPERTY OF SRP SIGN CORPORATION. USE OF THIS DRAWING'S CONTENTS OR DESIGN CONCEPTS FOR PURPOSES OTHER THAN ESTIMATING, DRAWING PREPARATION, AND/OR MANUFACTURING FOR SRP SIGN CORPORATION SHALL BE CAUSE FOR LEGAL RECOURSE BY SRP SIGN CORPORATION	 5
	CLIENT: AUGUST RADBILL			
	DRAWN BY: NICK MCGEE	DATE: 03-10-26		
	DESCRIPTION: EXTERIOR SIGNAGE			
	FILE LOCATION: Clients\Far Out Ice Cream\Cleveland Circle\Far_Out_Exterior_cc_v1			

Sub Copy
10-1/2" x 215-1/2" x 1-1/2" Fabricated Panel
1-1/2" x 1-1/2" Angle Frame
3/8" Acrylic Letters
Flush Mounted w/ VHB
Angle Mounting Brackets

Qty. (1)



ORANGE - PMS 172



BEIGE - AKZO NOBEL 432B1

SRPSIGN CORPORATION 236 PEARL STREET SOMERVILLE, MA 02145 (617) 623-6222	PROJECT: FAR OUT ICE CREAM	
	ADDRESS: 1930 BEACON STREET BOSTON, MA	
	CLIENT: AUGUST RADBILL	
	DRAWN BY: NICK MCGEE	DATE: 03-10-26
	DESCRIPTION: EXTERIOR SIGNAGE	
FILE LOCATION: Clients\Far Out Ice Cream\Cleveland Circle\Far_Out_Exterior_cc_v1		
<small>PROPRIETARY NOTICE: THIS DRAWING SHEET AND CONTENTS HEREIN ARE THE PROPERTY OF SRP SIGN CORPORATION. USE OF THIS DRAWING'S CONTENTS OR DESIGN CONCEPTS FOR PURPOSES OTHER THAN ESTIMATING, DRAWING PREPARATION, AND/OR MANUFACTURING FOR SRP SIGN CORPORATION SHALL BE CAUSE FOR LEGAL RECOURSE BY SRP SIGN CORPORATION</small>		
		 6

Sub Copy
 10-1/2" x 215-1/2" x 1-1/2" Fabricated Panel
 1-1/2" x 1-1/2" Angle Frame
 3/8" Acrylic Letters
 Flush Mounted w/ VHB
 Angle Mounting Brackets

Qty. (1)

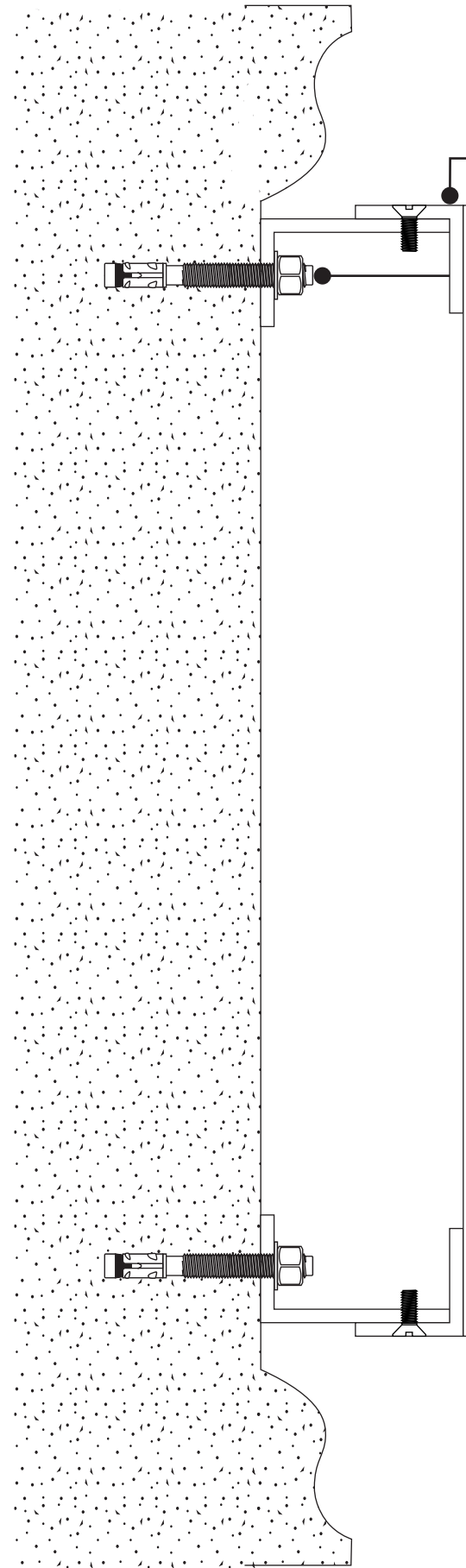



1-1/2" Angle Frame w/ Set Screw

Mechanical Fastener Securing L Bracket to Facade

.080 Aluminum Face

3/8" Acrylic Letters w/ VHB

 236 PEARL STREET SOMERVILLE, MA 02145 (617) 623-6222	PROJECT: FAR OUT ICE CREAM ADDRESS: 1930 BEACON STREET BOSTON, MA	PROPRIETARY NOTICE: THIS DRAWING SHEET AND CONTENTS HEREIN ARE THE PROPERTY OF SRP SIGN CORPORATION. USE OF THIS DRAWING'S CONTENTS OR DESIGN CONCEPTS FOR PURPOSES OTHER THAN ESTIMATING, DRAWING PREPARATION, AND/OR MANUFACTURING FOR SRP SIGN CORPORATION SHALL BE CAUSE FOR LEGAL RECOURSE BY SRP SIGN CORPORATION	 7	
	CLIENT: AUGUST RADBILL			
	DRAWN BY: NICK MCGEE			DATE: 03-10-26
	DESCRIPTION: EXTERIOR SIGNAGE			
	FILE LOCATION: Clients\Far Out Ice Cream\Cleveland Circle\Far_Out_Exterior_cc_v1			

Main ID
 20" x 5-1/2" Deep Face Lit Channel Letters
 1" Trim Cap
 3/16" White 2447 Acrylic Face
 3M 3630-44- Orange Translucent Vinyl Applied to Face
 Returns & Trim Painted to Match PMS 172
 (1) 3-1/2" x 3-1/2" x 49" Raceway Painted to Match Building Facade
 (1) 3-1/2" x 3-1/2" x 54" Raceway Painted to Match Building Facade
 Power Supply Inside Raceway

Qty. (1)



 ORANGE - PMS 172 = Avery 900 Translucent Orange



 To Match Building Facade

SRPSIGN CORPORATION 236 PEARL STREET SOMERVILLE, MA 02145 (617) 623-6222	PROJECT: FAR OUT ICE CREAM		<small>PROPRIETARY NOTICE: THIS DRAWING SHEET AND CONTENTS HEREIN ARE THE PROPERTY OF SRP SIGN CORPORATION. USE OF THIS DRAWING'S CONTENTS OR DESIGN CONCEPTS FOR PURPOSES OTHER THAN ESTIMATING, DRAWING PREPARATION, AND/OR MANUFACTURING FOR SRP SIGN CORPORATION SHALL BE CAUSE FOR LEGAL RECOURSE BY SRP SIGN CORPORATION</small>	
	ADDRESS: 1930 BEACON STREET BOSTON, MA			
	CLIENT: AUGUST RADBILL			
	DRAWN BY: NICK MCGEE	DATE: 03-10-26		
	DESCRIPTION: EXTERIOR SIGNAGE			
FILE LOCATION: Clients\Far Out Ice Cream\Cleveland Circle\Far_Out_Exterior_cc_v1			8	

Window Vinyl
 Various Widths & Heights
 3M Bright Orange Vinyl Text
 3M 7125 Fawn Vinyl Text
 Digitally Printed Optically Clear Vinyl Leaves and Ice Cream
 Second Surface Application

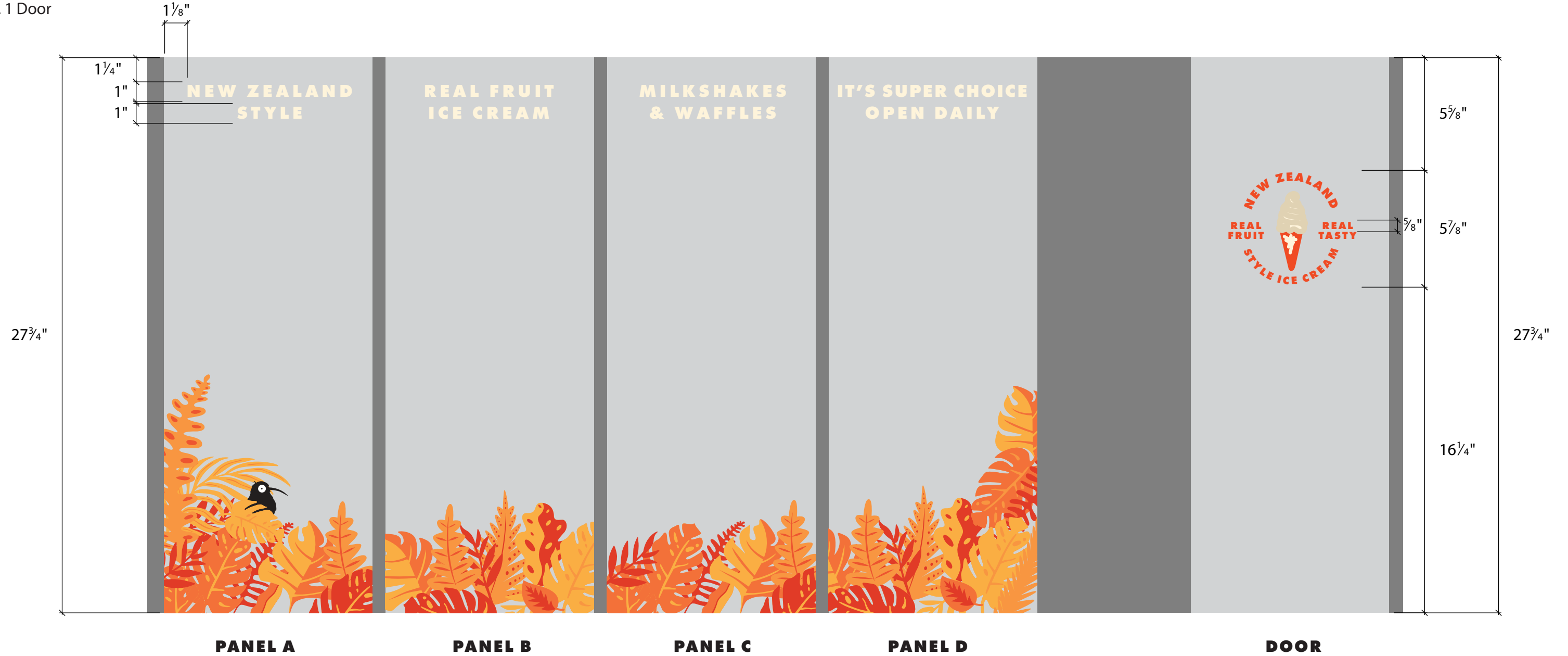
Qty. 4 Windows
 Qty. 1 Door



-  Avery 750 Tangerine Vinyl
-  3M 7125 Fawn Vinyl Text
-  Digitally Printed Optically Clear Vinyl Leaves & Ice Cream

SRPSIGN CORPORATION 236 PEARL STREET SOMERVILLE, MA 02145 (617) 623-6222	PROJECT: FAR OUT ICE CREAM		PROPRIETARY NOTICE: THIS DRAWING SHEET AND CONTENTS HEREIN ARE THE PROPERTY OF SRP SIGN CORPORATION. USE OF THIS DRAWING'S CONTENTS OR DESIGN CONCEPTS FOR PURPOSES OTHER THAN ESTIMATING, DRAWING PREPARATION, AND/OR MANUFACTURING FOR SRP SIGN CORPORATION SHALL BE CAUSE FOR LEGAL RECOURSE BY SRP SIGN CORPORATION	 9
	ADDRESS: 1930 BEACON STREET BOSTON, MA			
	CLIENT: AUGUST RADBILL	DATE: 03-10-26		
	DRAWN BY: NICK MCGEE			
DESCRIPTION: EXTERIOR SIGNAGE				
FILE LOCATION: Clients\Far Out Ice Cream\Cleveland Circle\Far_Out_Exterior_cc_v1				



Existing Conditions

Proposed Conditions

SRPSIGN CORPORATION 236 PEARL STREET SOMERVILLE, MA 02145 (617) 623-6222	PROJECT: FAR OUT ICE CREAM ADDRESS: 1930 BEACON STREET BOSTON, MA	PROPRIETARY NOTICE: THIS DRAWING SHEET AND CONTENTS HEREIN ARE THE PROPERTY OF SRP SIGN CORPORATION. USE OF THIS DRAWING'S CONTENTS OR DESIGN CONCEPTS FOR PURPOSES OTHER THAN ESTIMATING, DRAWING PREPARATION, AND/OR MANUFACTURING FOR SRP SIGN CORPORATION SHALL BE CAUSE FOR LEGAL RECOURSE BY SRP SIGN CORPORATION		
	CLIENT: AUGUST RADBILL			
	DRAWN BY: NICK MCGEE			DATE: 03-10-26
	DESCRIPTION: EXTERIOR SIGNAGE			
	FILE LOCATION: Clients\Far Out Ice Cream\Cleveland Circle\Far_Out_Exterior_cc_v1			
		10		