

Sally's PIZZA

EXTERIOR MODIFICATIONS SUBMISSION
30 THOMSON PLACE ALLEY



DESIGN REVIEW TOPICS

LOCATION OF BUILDING WITHIN DISTRICT

EXISTING PHOTOS

PROPOSED ELEMENTS

- 30 THOMSON PLACE - EXISTING CONDITIONS
- 30 THOMSON PLACE - ARCHITECTURAL MODIFICATIONS
- 30 THOMSON PLACE – MECHANICAL DETAILS
- 30 THOMSON PLACE – ROOFTOP EQUIPMENT SIGHTLINES AND LAYOUT

NEIGHBORHOOD PHOTOS

HISTORIC PHOTOS

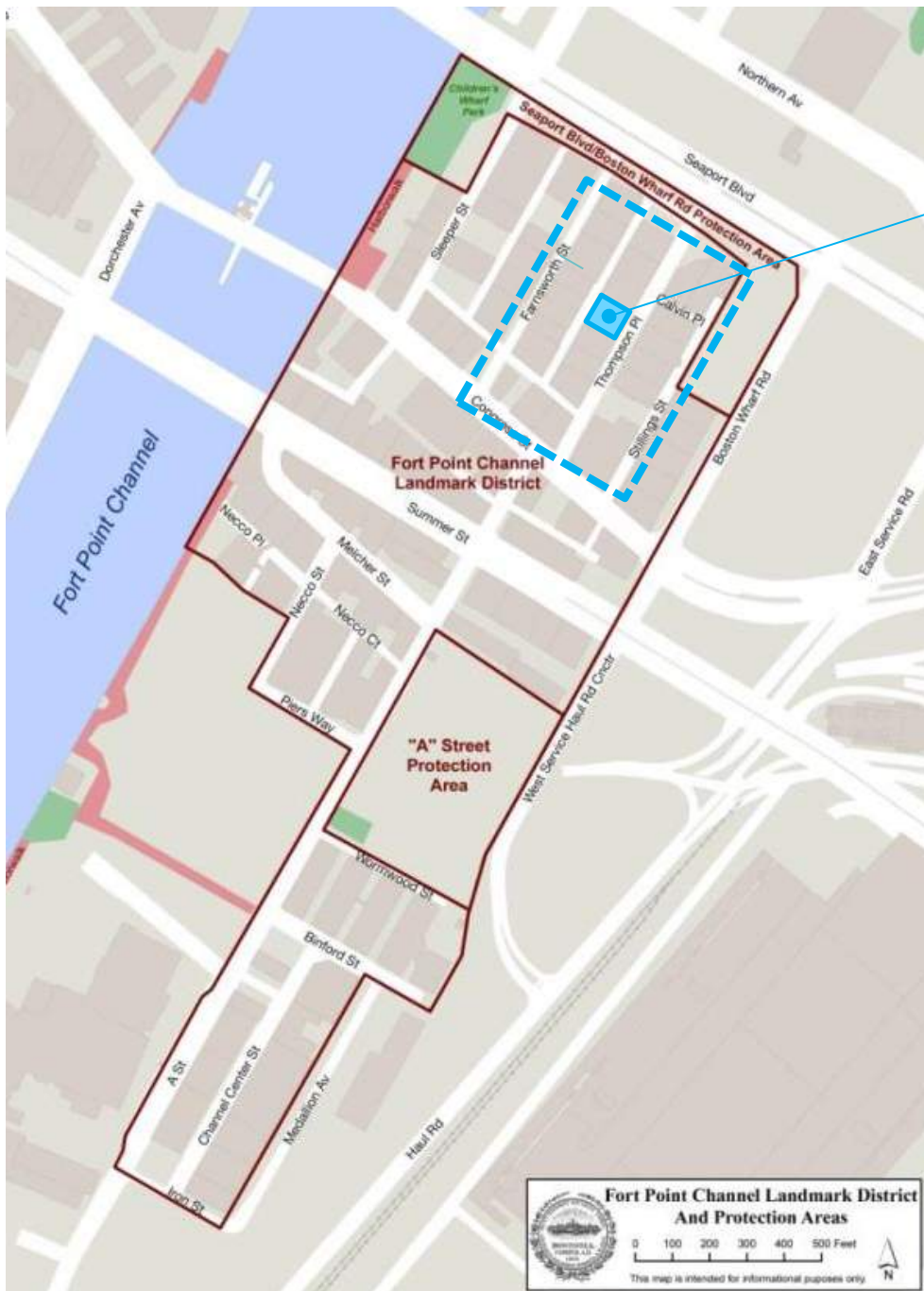

30 THOMSON PLACE

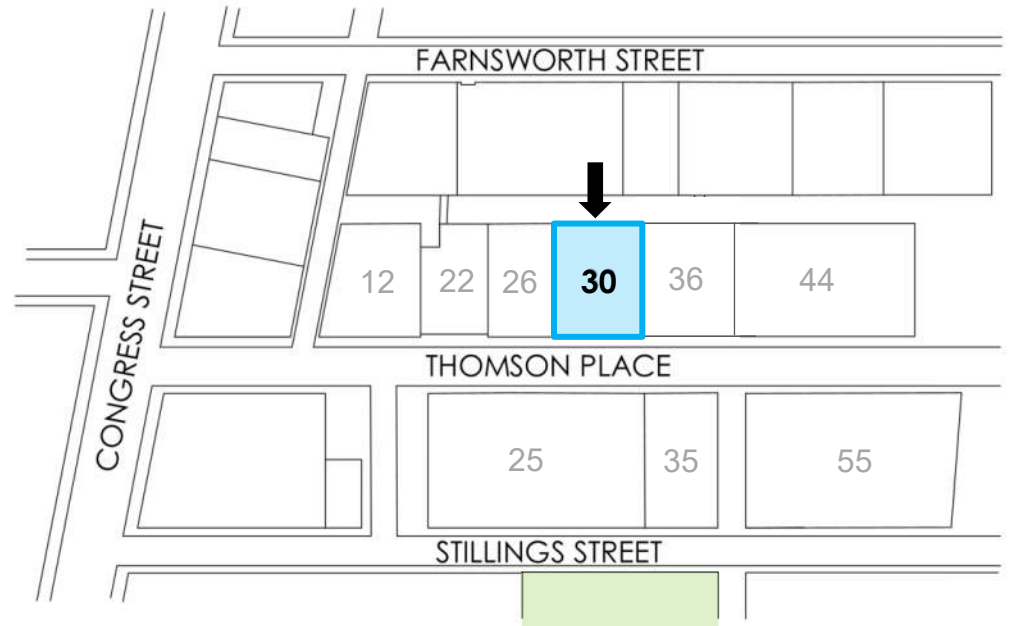

PROJECT LOCATION MAP

FORT POINT CHANNEL LANDMARK DISTRICT

03.19.2024





VIEW FROM LEFT CORNER



VIEW FROM RIGHT CORNER



PHOTO COMPILATION OF ELEVATION

EXISTING CONDITION PHOTOS

03.19.2024



ELEVATION OF PROPOSED CHANGES

03.19.2024

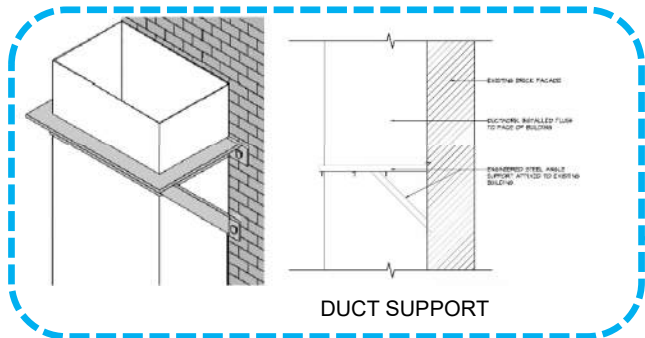

DUCT SUPPORT

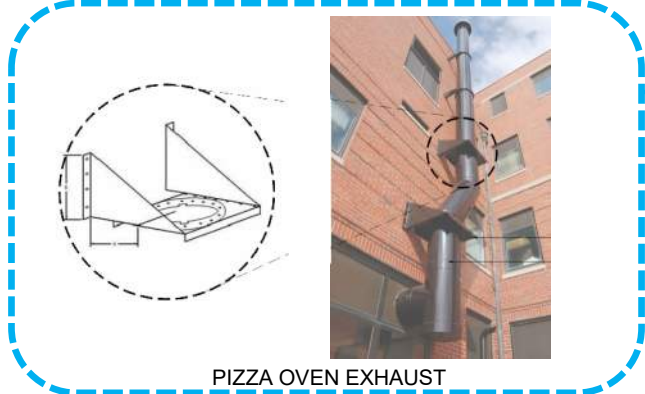

PIZZA OVEN EXHAUST

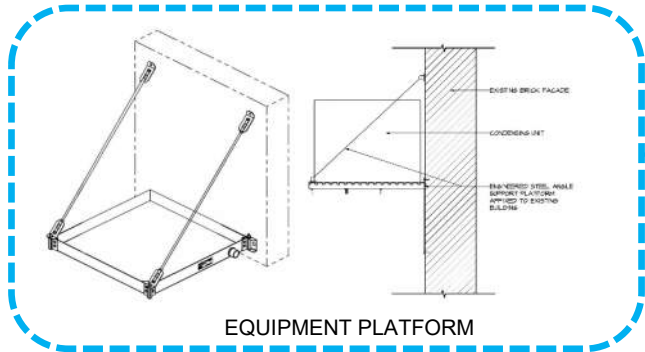

EQUIPMENT PLATFORM

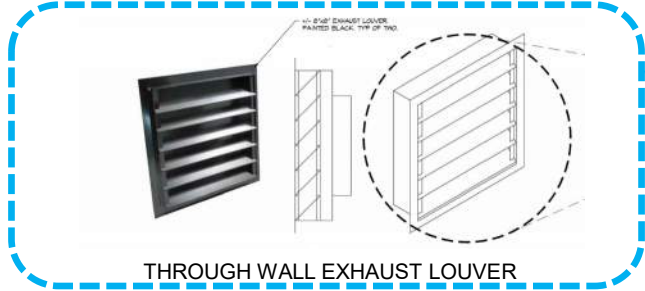

THROUGH WALL EXHAUST LOUVER



MECHANICAL DETAILS

03.19.2024



ELEVATION OF MODIFICATIONS

03.19.2024





RENDERED ELEVATION OF PROPOSED CHANGES

03.19.2024





RENDERED VIEW OF PROPOSED CHANGES

03.19.2024



RENDERED VIEW OF PROPOSED CHANGES

03.19.2024

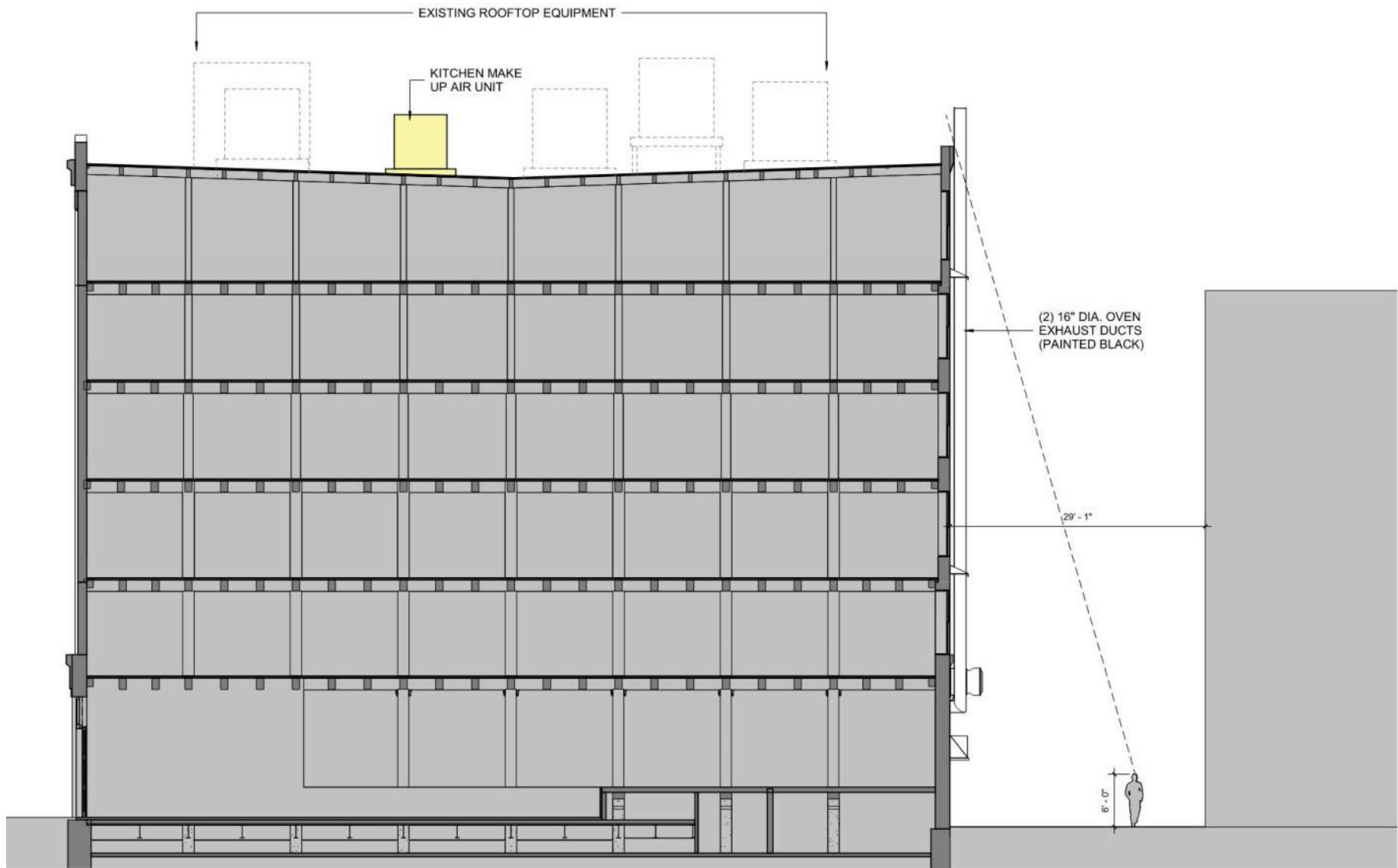

THOMSON PLACE

30 THOMSON PLACE

ALLEY

FARNSWORTH GARAGE

BUILDING CROSS SECTION SHOWING SIGHTLINES

03.19.2024



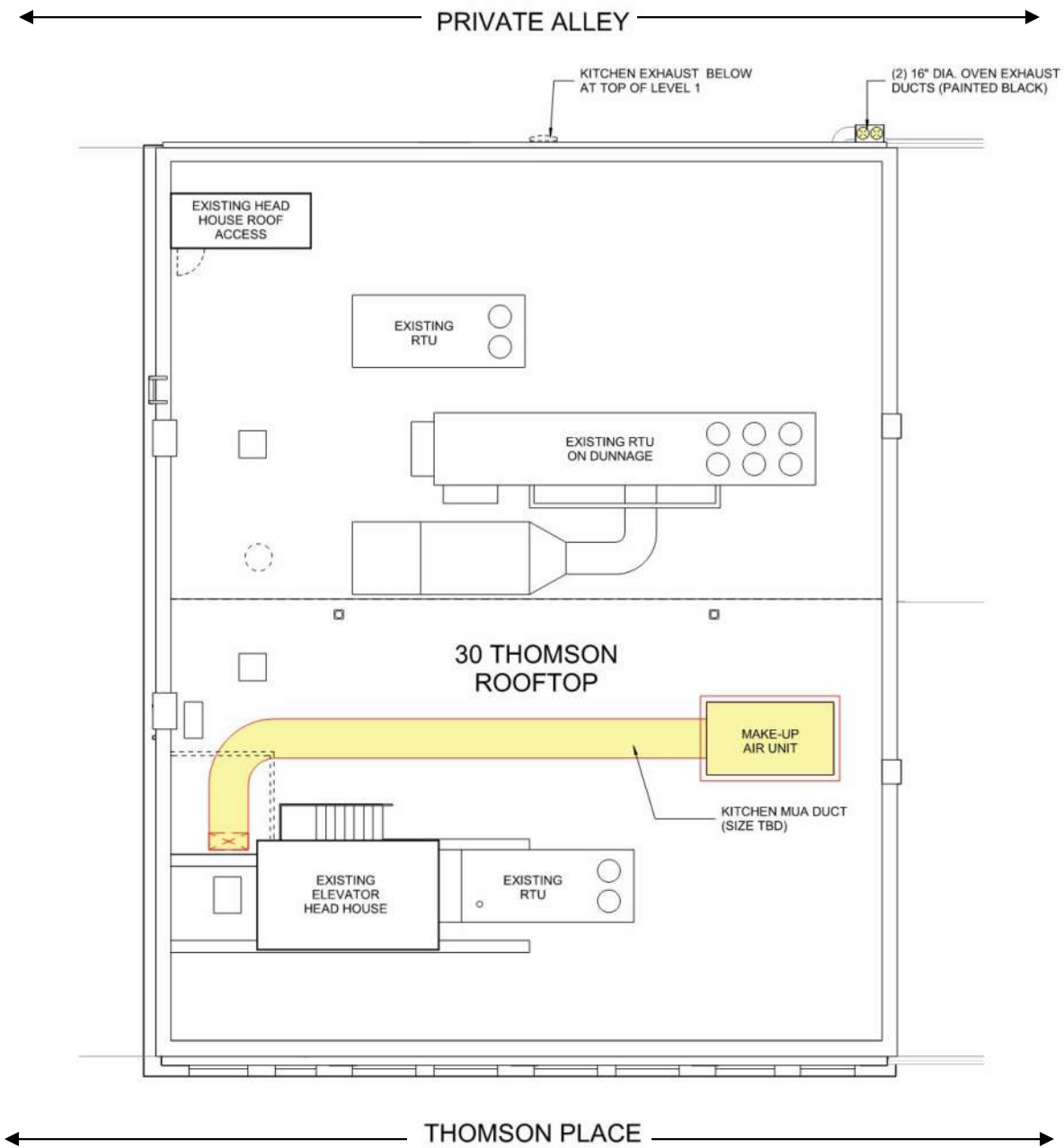

ROOFTOP EQUIPMENT PLAN

03.19.2024



FIRST FLOOR PLAN DIAGRAM

03.19.2024



SURFACE MOUNTED DUCTWORK BEHIND "METRO" SPACE



SURFACE MOUNTED DUCTWORK BEHIND "LUCKY'S"

NEIGHBORHOOD PHOTOS OF DUCTWORK EXAMPLES

03.19.2024



CONDENSERS BEHIND 343 CONGRESS STREET

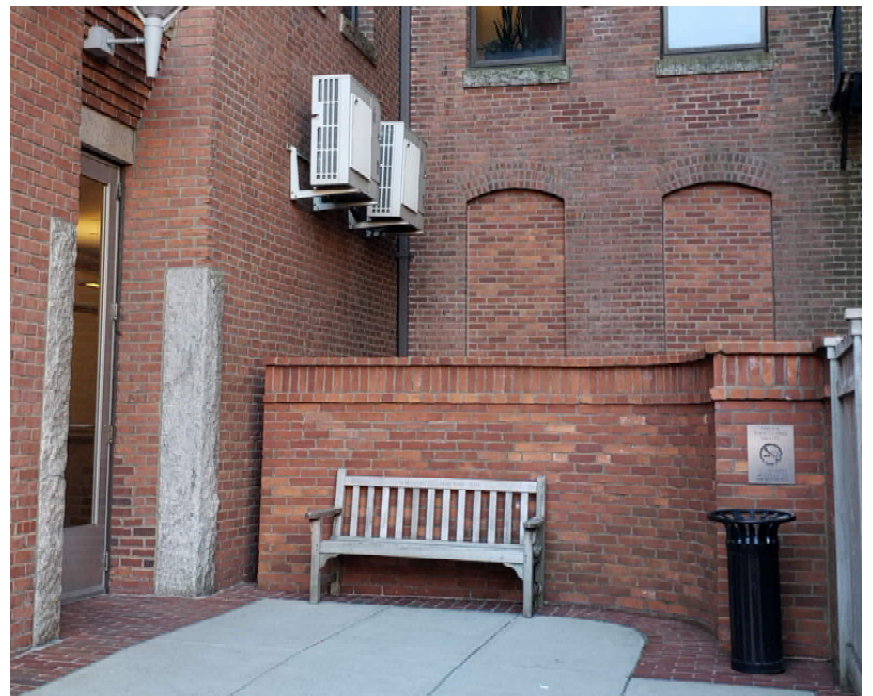

CONDENSERS BEHIND 274 SUMMER STREET



CONDENSERS BEHIND 281-283 SUMMER STREET

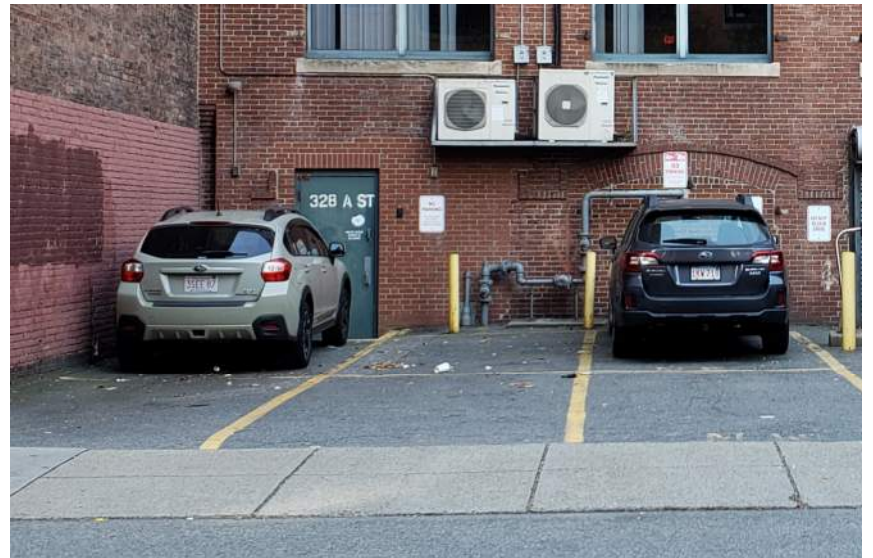

CONDENSERS AT 328 STREET

NEIGHBORHOOD PHOTOS OF WALL MOUNTED EQUIPMENT

03.19.2024

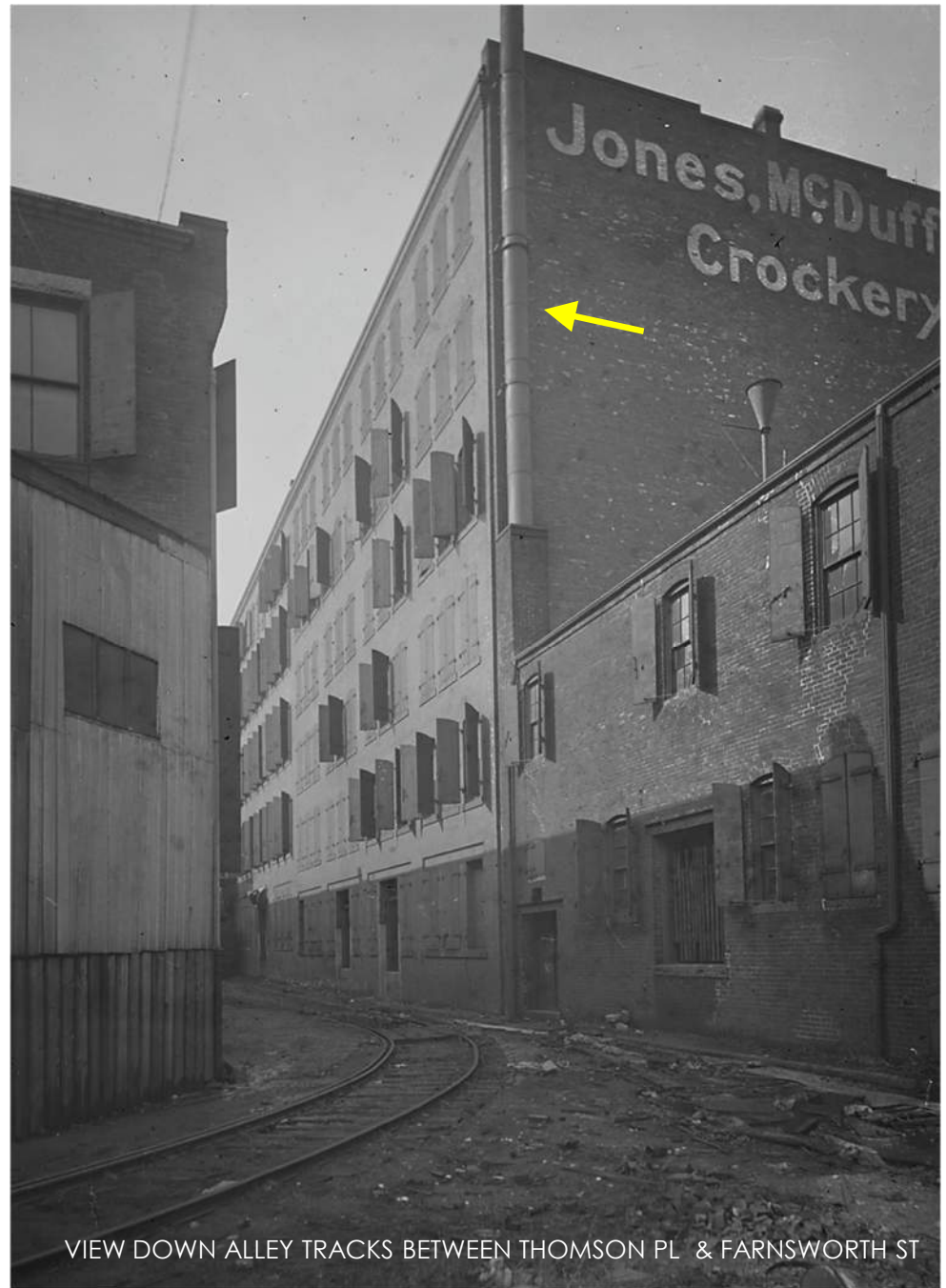
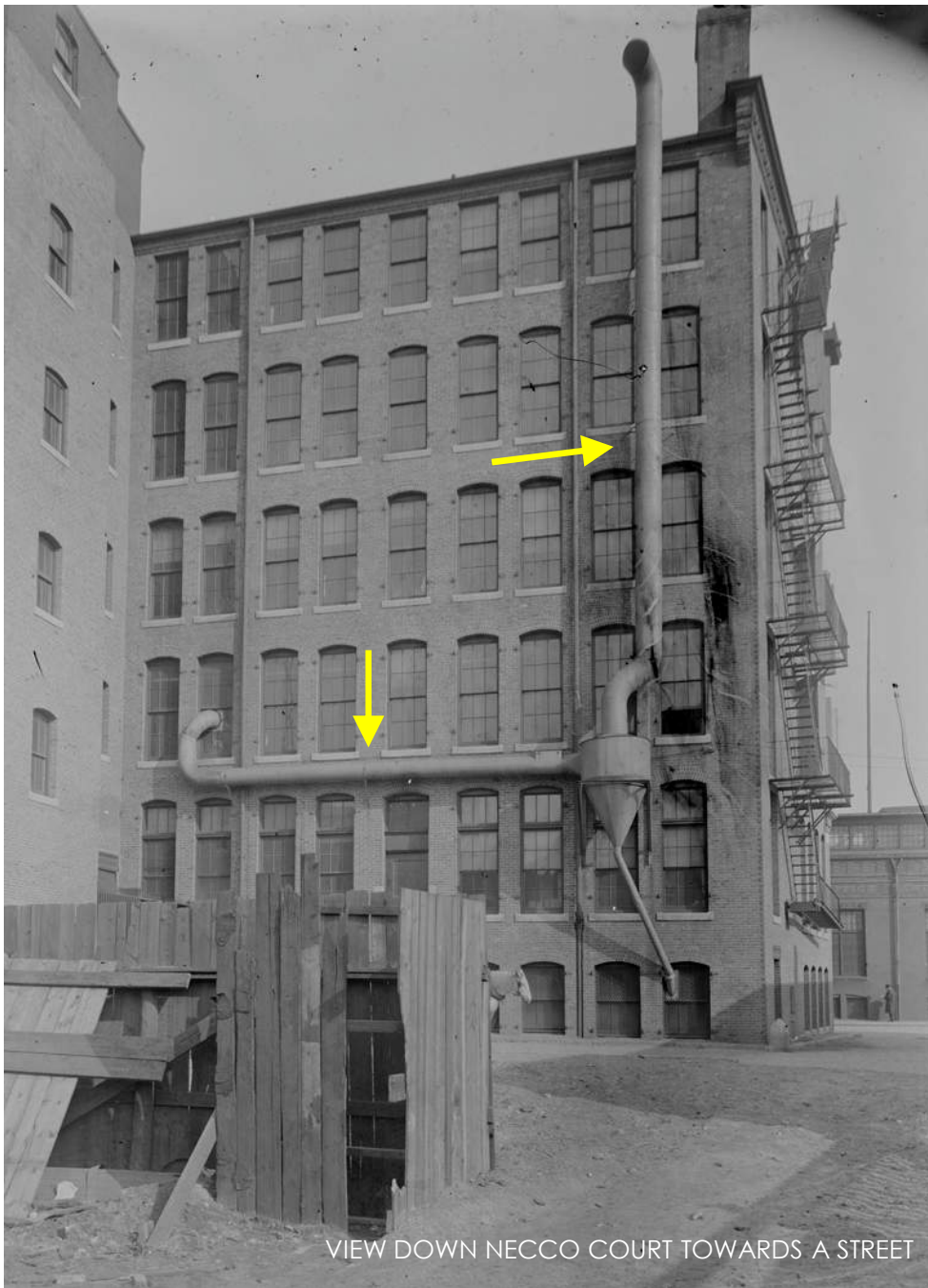

HISTORIC PHOTOS OF VENT STACKS FOR REFERENCE

03.19.2024



VIEW FROM ALLEY LOOKING EAST



VIEW FROM 30 THOMSON
LOOKING EAST



VIEW FROM 36 THOMSON
LOOKING WEST

MOCK-UP PHOTOS: EXHAUST DUCT

03.19.2024



MOCK-UP PHOTOS: MUA UNIT

03.19.2024

Sally's **PIZZA**

THANK YOU