



BIG RED ROOSTER FLOW

PROJECT LOCATION:

785 Tremont Street
Boston, MA 02118

PROJECT OVERVIEW:

- A** Site Map
- B** Canopy Visuals
- C** Dispenser Visuals
- D** Main ID Visuals
- E** Color / Paint Specifications

approval signature

I have reviewed the visuals within this document and I approve the designs and scope of work listed within.



EXISTING



PROPOSED

Project Name	Facility #	Customer	Created by
GULF	92044485	GULF	A.AGAM
Revision #	Date	Scale	Page #
Original	09_09_2019	NA	1 OF 9

Permit Pack
BIG RED ROOSTER FLOW
 2 Northfield Plaza, Ste 250
 Northfield, IL 60093
 P: (847) 441-1818 F: (847) 592-9564

A Site Map

SITE PLAN

- A** Gulf Word Mark
- B** Gulf Disc
- C** Canopy
- D** Main ID

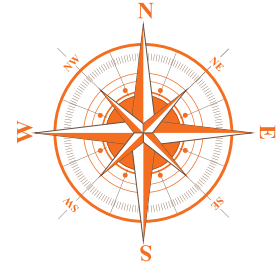

Project Name	Facility #	Customer	Created by
GULF	92044485	GULF	A.AGAM
Revision #	Date	Scale	Page #
Original	09_09_2019	NA	2 OF 9

Permit Pack
BIG RED ROOSTER FLOW
 2 Northfield Plaza, Ste 250
 Northfield, IL 60093
 P: (847) 441-1818 F: (847) 592-9564

B Canopy 1 Reface

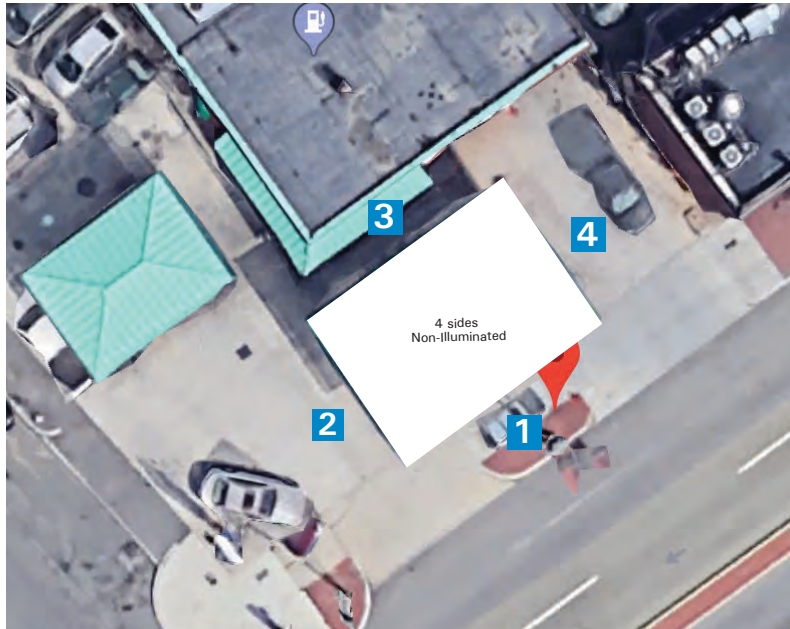

Overhead Map



Perspective View

Elevation 1 NON-ILLUMINATED

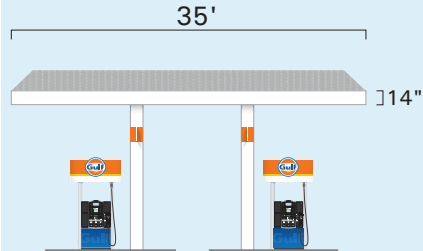

Elevation 2 NON-ILLUMINATED

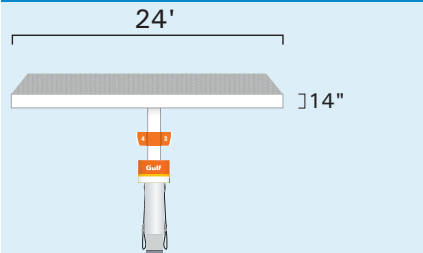

Elevation 3 NON-ILLUMINATED

Distance from the building to the nearest edge of canopy: 9'8"

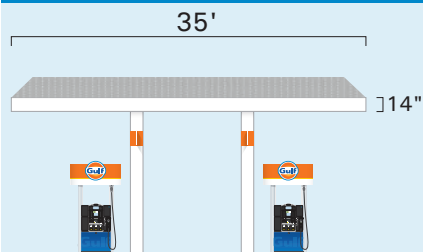

Elevation 4 NON-ILLUMINATED

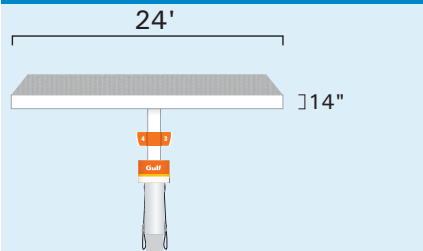

Project Name	Facility #	Customer	Created by
GULF	92044485	GULF	A.AGAM
Revision #	Date	Scale	Page #
Original	09_09_2019	NA	3 OF 9

Permit Pack
BIG RED ROOSTER FLOW
 2 Northfield Plaza, Ste 250
 Northfield, IL 60093
 P: (847) 441-1818 F: (847) 592-9564

B

Canopy 2 Reface

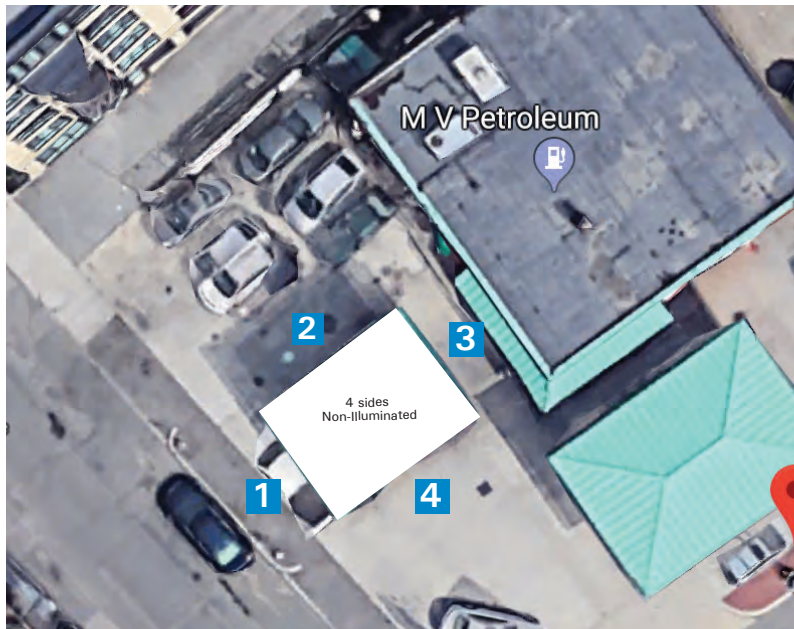

Overhead Map



Perspective View

Elevation 1 NON-ILLUMINATED

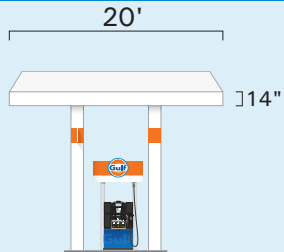

Elevation 2 NON-ILLUMINATED

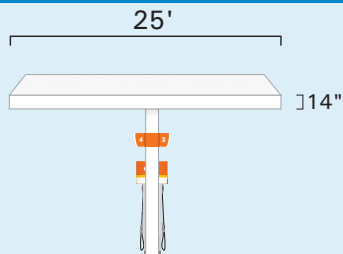

Elevation 3 NON-ILLUMINATED

Distance from the building to the nearest edge of canopy: 12'

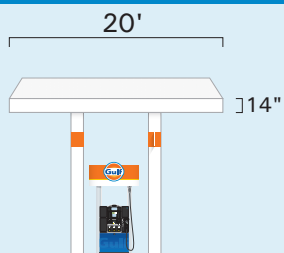

Elevation 4 NON-ILLUMINATED

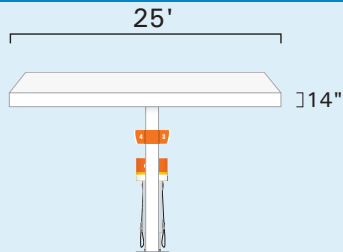

Project Name	Facility #	Customer	Created by
GULF	92044485	GULF	A.AGAM
Revision #	Date	Scale	Page #
Original	09_09_2019	NA	4 OF 9

Permit Pack
BIG RED ROOSTER FLOW
 2 Northfield Plaza, Ste 250
 Northfield, IL 60093
 P: (847) 441-1818 F: (847) 592-9564

B Clearance

Note:
1. Canopy Clearance
 Sign should be positioned in the most visible sight lines for consumers entering the forecourt.

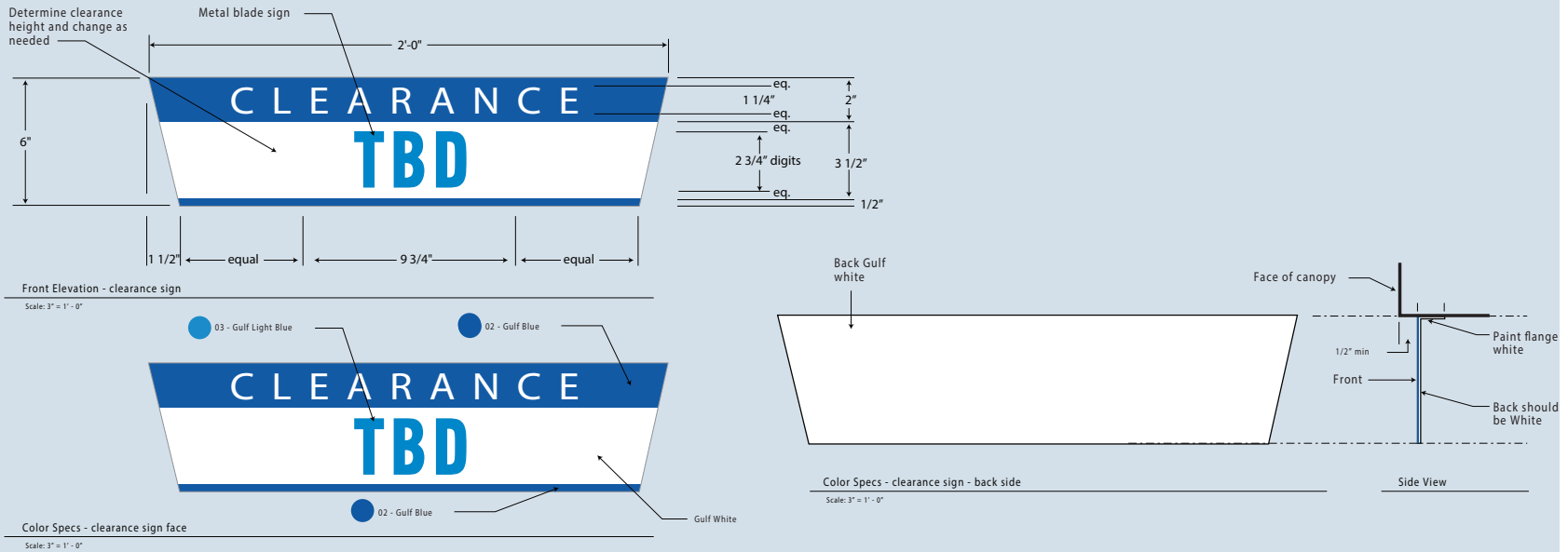

2. Align off column as first priority. If that location does not provide adequate visibility, move to a position that does.

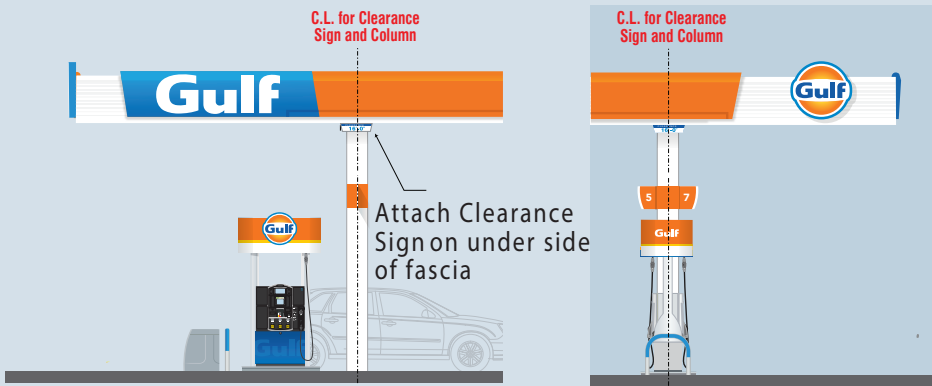

3. Do not position Clearance sign under a Gulf word mark sign or Gulf disc sign. Follow rules established on this sheet

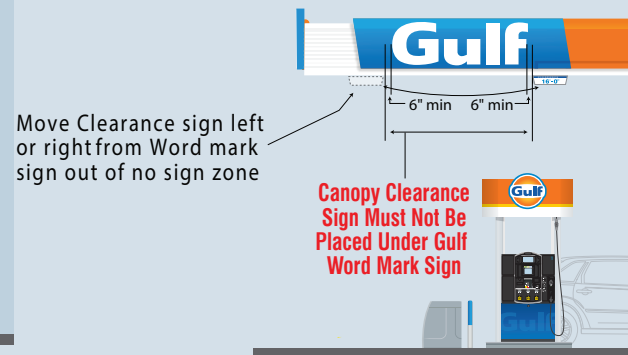

4. (2) Clearance signs are typically used per canopy. If more are needed, seek approval from Gulf reimage team

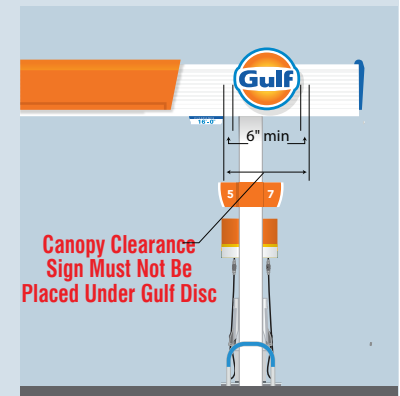

Project Name	Facility #	Customer	Created by
GULF	92044485	GULF	A.AGAM
Revision #	Date	Scale	Page #
Original	09_09_2019	NA	5 OF 9

Permit Pack
BIG RED ROOSTER FLOW
 2 Northfield Plaza, Ste 250
 Northfield, IL 60093
 P: (847) 441-1818 F: (847) 592-9564

C Dispensers

State/local regulatory messages are the responsibility of Gulf Oil's dealer/distributor

*While reimaging the dispensers, if the weights and measures labels have to be altered please remove them and place them on a 8.5"x11" paper and hand deliver to a store representative. Ask the store representative to call the listed number for a new test.



Existing

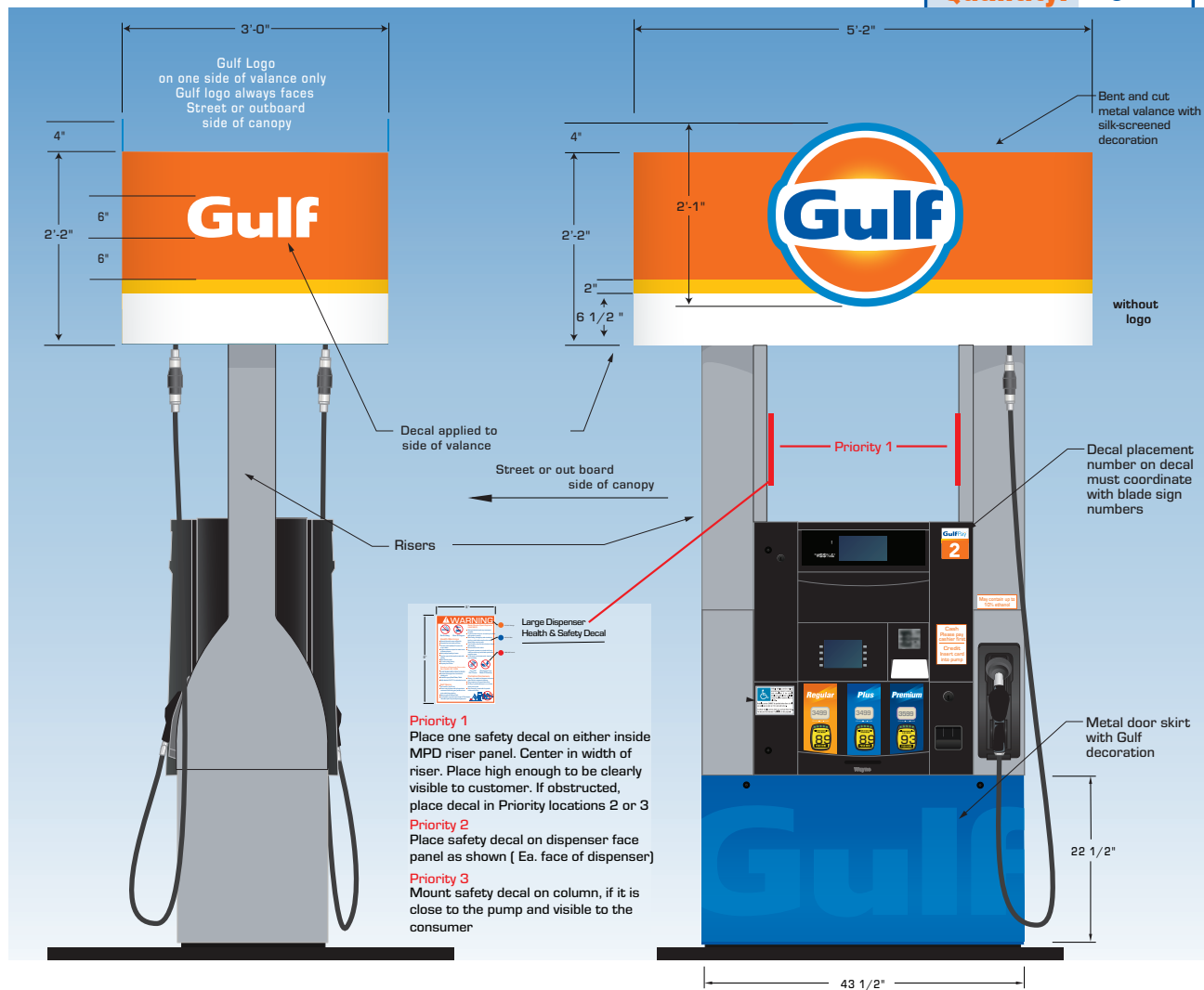

Proposed Existing

Wayne Ovation 2 3+0

Project Name	Facility #	Customer	Created by
GULF	92044485	GULF	A.AGAM
Revision #	Date	Scale	Page #
Original	09_09_2019	NA	6 OF 9

Permit Pack
BIG RED ROOSTER FLOW
 2 Northfield Plaza, Ste 250
 Northfield, IL 60093
 P: (847) 441-1818 F: (847) 592-9564

D MID Sign

- Reface and add new internal LED's on the Gulf logo cabinet.
- Reface and add new internal LED's on the price cabinet.
- Add new 12" conventional font digits on 2 product price cabinet.



Existing

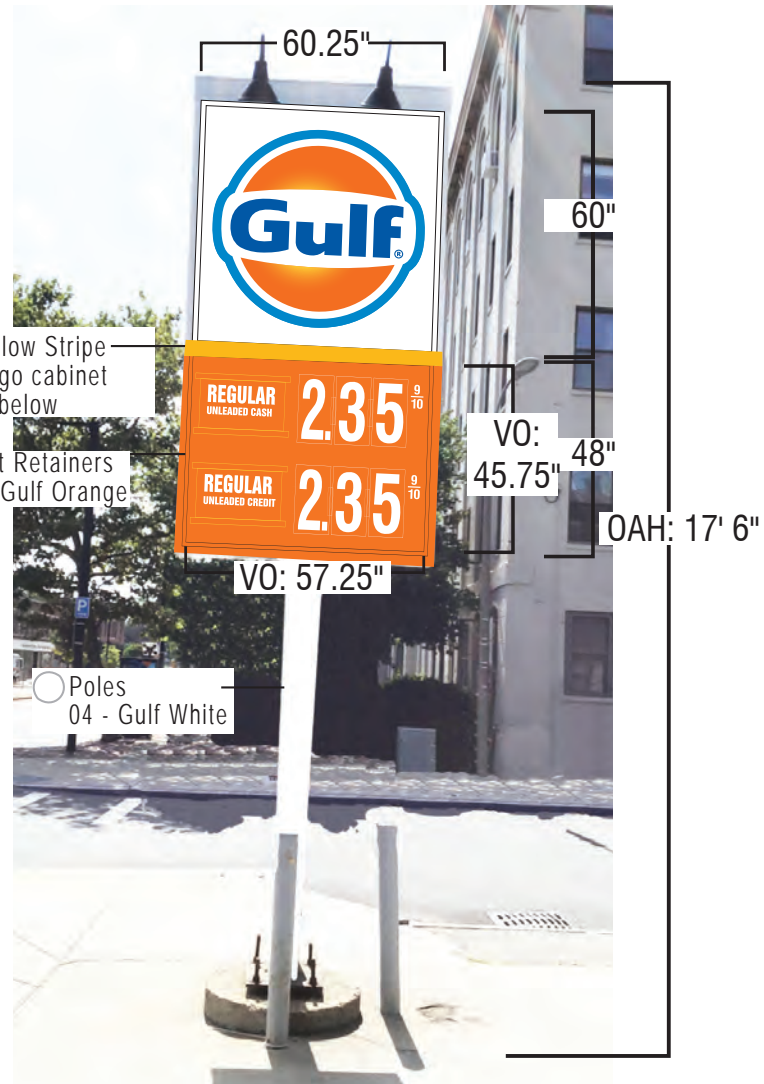

Proposed : REFACE

Project Name	Facility #	Customer	Created by
GULF	92044485	GULF	A.AGAM
Revision #	Date	Scale	Page #
Original	09_09_2019	NA	7 OF 9

Permit Pack
BIG RED ROOSTER FLOW
 2 Northfield Plaza, Ste 250
 Northfield, IL 60093
 P: (847) 441-1818 F: (847) 592-9564

E

Color Specifications

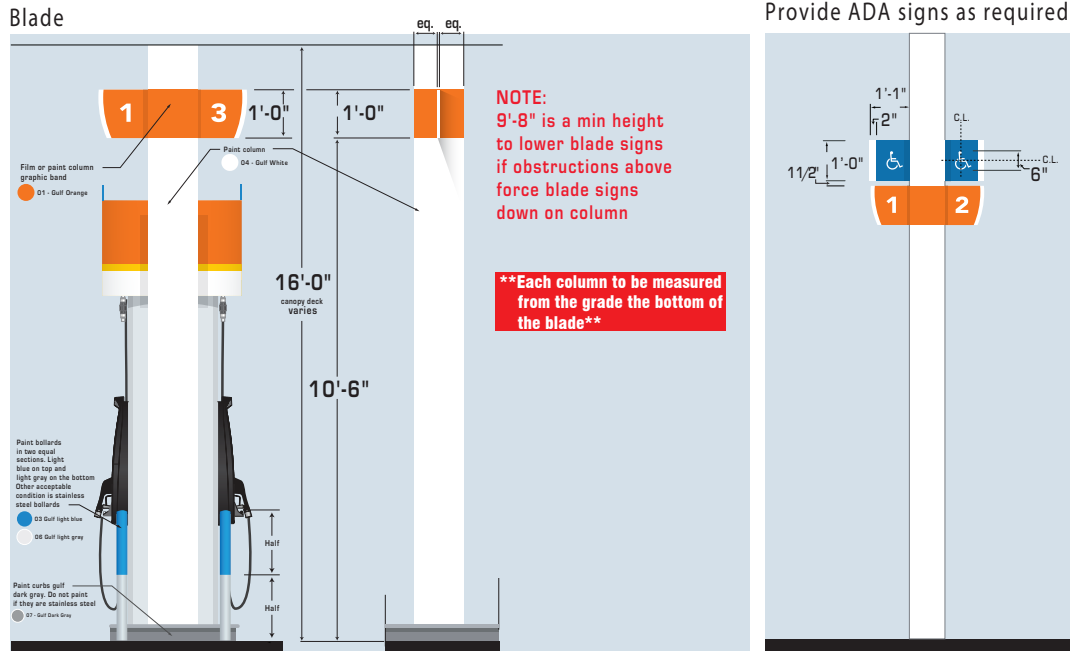

NOTE: Towel dispensers should be removed from canopy columns and given to the dealer/site management should they want to keep them OR disposed of in installer supplied dumpsters.

NOTE: Fire extinguisher cabinets should be removed prior to painting the canopy columns and reinstalled after painting the columns.

Islands

Paint curbs: 07 - Gulf Dark Gray

Do not paint stainless steel



Bollards

Paints bollards: 03 - Gulf Light Blue (HALF)
06 - Gulf Light Gray

Do not paint stainless steel

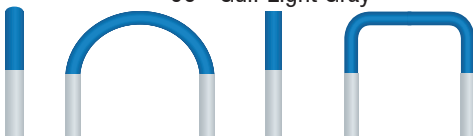

- 01 - Gulf Orange** PMS 165C
Forecourt: Fascia Component, Dispenser Valance, Blade Signs
3M Bright Orange -180MC 14
Sherwin Williams Custom Color - Paint Spe@Paint Finish - Semi Gloss
- 02 - Gulf Blue** PMS 2935C
Forecourt: Fascia Component, Dispenser Valance, Dispenser Skirt
3M Film Intense Blue 180 - 47
Sherwin Williams Custom Color - Paint Spe@Paint Finish - Semi Gloss
- 03 - Gulf Light Blue** PMS Process BLUE C
Forecourt: Dispenser Skirt, Top of Bollard
3M Film Olympic Blue 180 - 57
Sherwin Williams Custom Color - Paint Spe@Paint Finish - Semi Gloss
- 04 - Gulf White - Paint**
Forecourt: Columns, Dispenser Valance, Blade Signs
Sherwin Williams - Snow Bound SW-7004 White.Paint Finish - Satin
- 05 - Gulf Yellow** PMS 1235C
Forecourt: Fascia Component, Dispenser Valance, MID
3M Film Sunflower yellow 3650-25
Sherwin Williams Custom Color - Paint SpecPaint Finish - Semi Gloss
- 06 - Gulf Light Gray**
Forecourt: Bollard lower section
Sherwin Williams - Argos SW7065 - Paint Finish - Semi Gloss
- 07 - Gulf Dark Gray**
Forecourt: Curb Paint
Sherwin Williams - City Scope - SW -7067Paint Finish - Satin
- 08 - White ACM**
Forecourt: Fascia of Canopy
Reynobond Duragloss 3000 bright white Eastman White or equal
- 09 - Gulf White Canopy Deck - Paint**
Forecourt: Canopy Deck
Sherwin Williams - Extra White SW-7006 White Paint Finish - Semi Gloss
- 10 - Gulf Gray**
Forecourt: Canopy Fascia Lines
Custom Mix from LSI - Semi Gloss
- 11 - Gulf Diesel Green** PMS match 355
Forecourt: All Diesel applications, Dispensers, MID
- Wainscot Gray**
Sherwin Williams
7016 Mindful Gray

Project Name	Facility #	Customer	Created by
GULF	92044485	GULF	A.AGAM
Revision #	Date	Scale	Page #
Original	09_09_2019	NA	8 OF 9

Permit Pack
BIG RED ROOSTER FLOW
2 Northfield Plaza, Ste 250
Northfield, IL 60093
P: (847) 441-1818 F: (847) 592-9564



Paint Specifications



01 - Gulf Orange
MID poles
Sherwin Williams -
Custom Color Mix
Semi Gloss



04 - Gulf White - Paint
Forecourt: Columns,
Light Poles, Stacks etc
Sherwin Williams -
Snow Bound SW-7004 White
Satin



07 - Gulf Dark Gray
Forecourt: Curb Paint
Sherwin Williams -
City Scope - SW -7067
Paint Finish - Satin



02 - Gulf Blue
Forecourt: Presently not used
Sherwin Williams -
Custom Color Mix
Paint Finish - Semi Gloss



05 - Gulf Yellow
MID Band - poles and cabinet
Sherwin Williams -
Custom Color Mix
Semi Gloss



09 - Gulf White Canopy Deck
Forecourt:
Canopy deck
Sherwin Williams -
Extra White SW-7006 White
Paint Finish - Semi Gloss



03 - Gulf Light Blue
Forecourt: Top of Bollard
Sherwin Williams -
Custom Color Mix
Semi Gloss



06 - Gulf Light Gray
Forecourt: Bollard lower section
Sherwin Williams -
Argos SW7065
Paint Finish - Semi Gloss

Project Name	Facility #	Customer	Created by
GULF	92044485	GULF	A.AGAM
Revision #	Date	Scale	Page #
Original	09_09_2019	NA	9 OF 9

Permit Pack
BIG RED ROOSTER FLOW
 2 Northfield Plaza, Ste 250
 Northfield, IL 60093
 P: (847) 441-1818 F: (847) 592-9564