

NEW WINDOW DETAILS

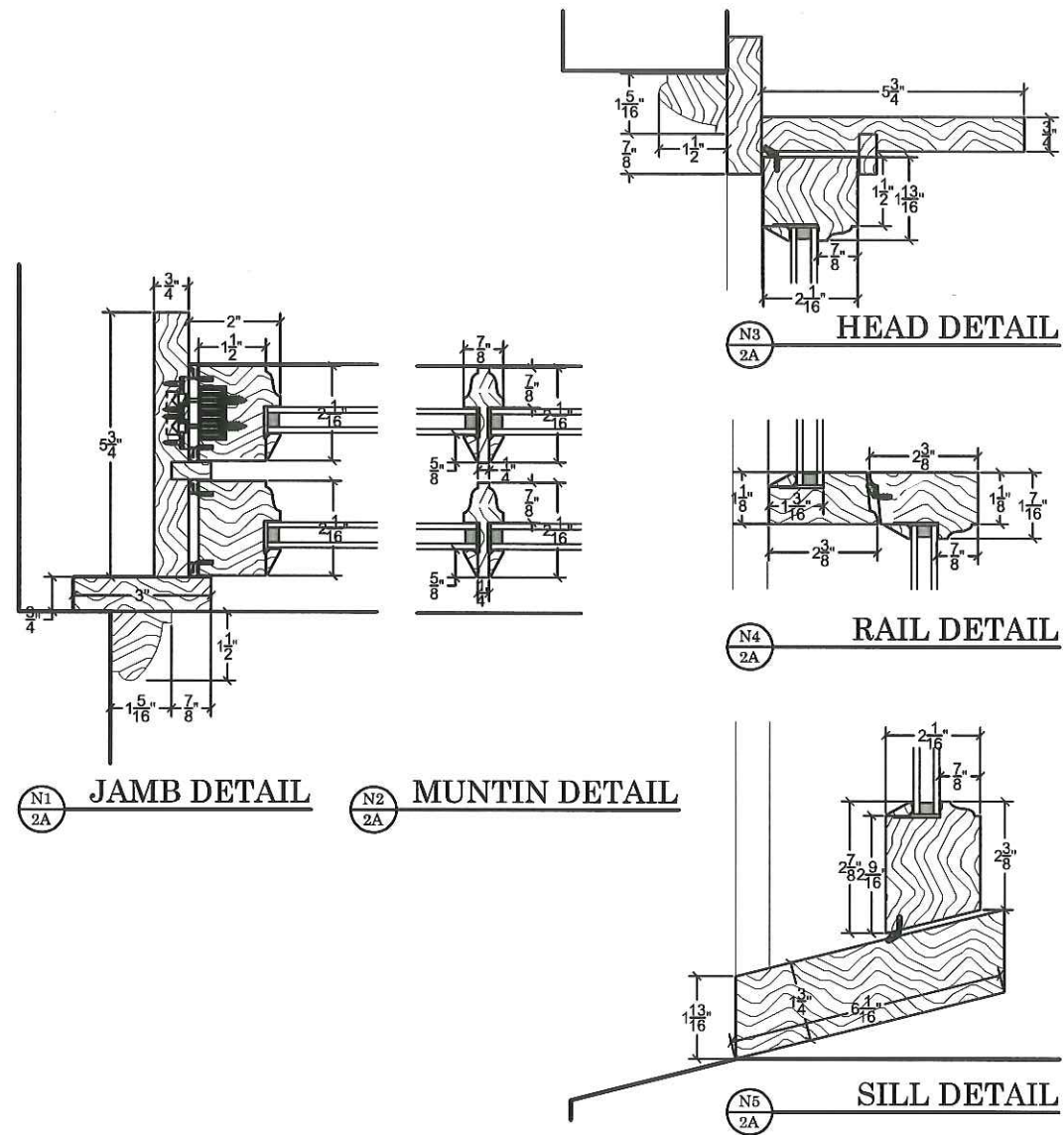

Project: 35 Bowdoin Street Boston, MA 02114

Task: Window Survey, Observations Made on June 18, 2015 & January 17, 2019

I. Location Plan:

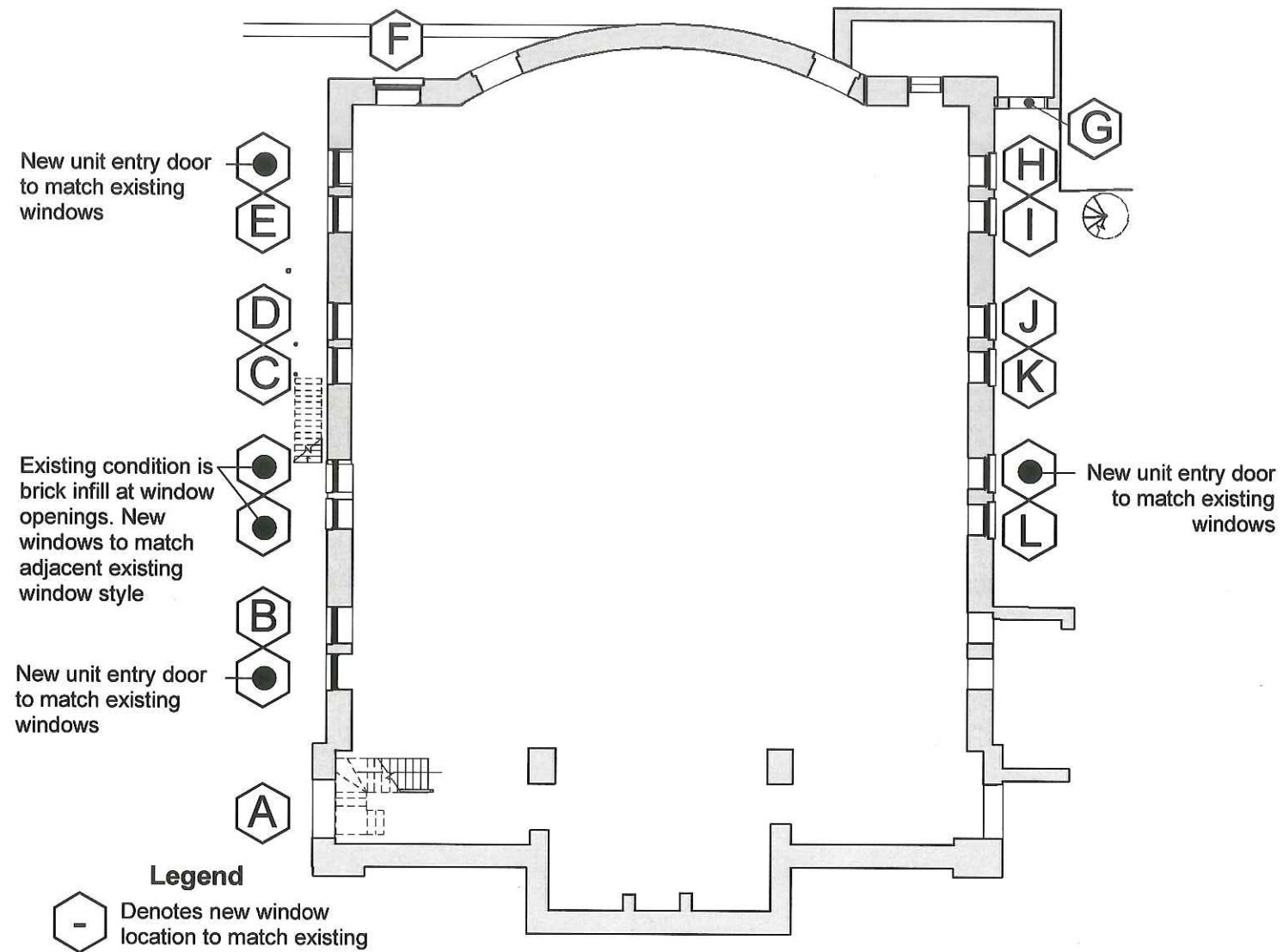

Window Notes	General Category
W1	Damaged frame
W2	Damaged or missing sash stop
W3	Damaged muntin
W4	Damaged or missing sash stop at sill
W5	Damaged glass
W6	Remove added security bar not original to window

EXISTING WINDOW PHOTO - TYPE B

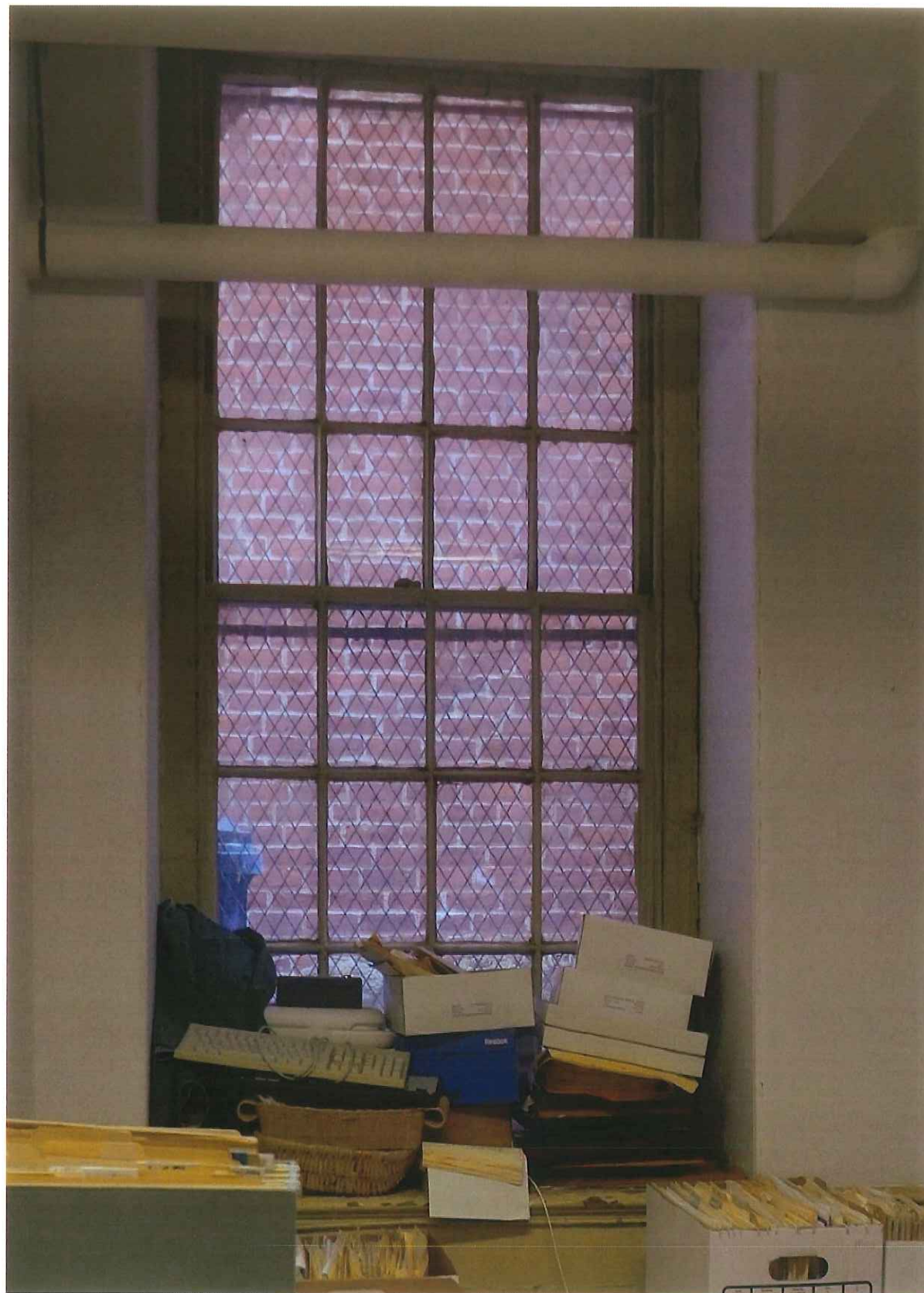

EXISTING WINDOW - TYPE B

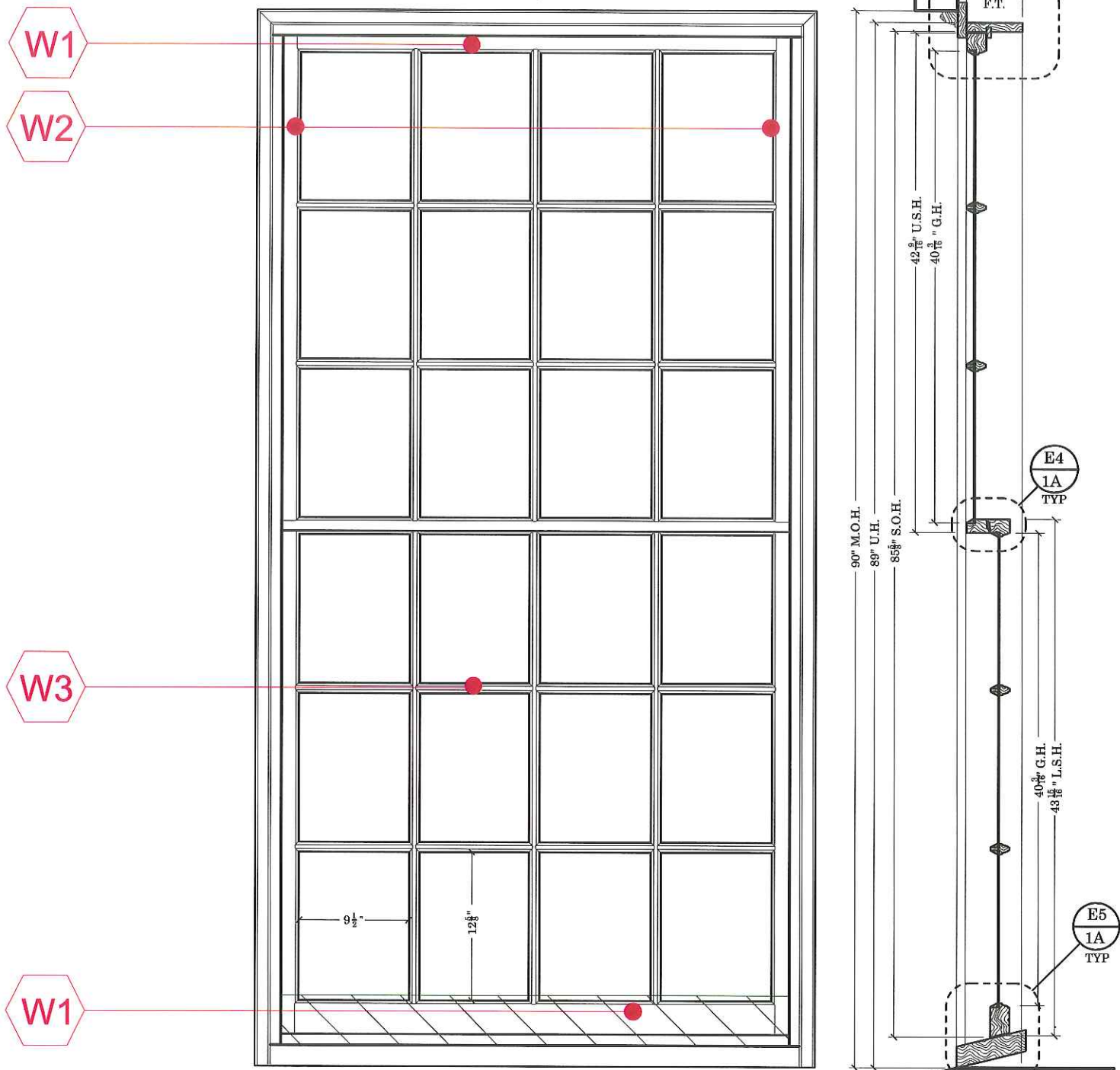

ELEVATION

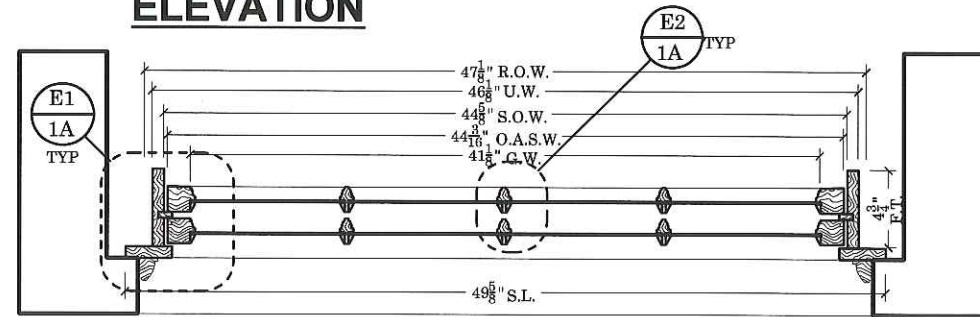

PLAN

SECTION

EXISTING WINDOW PHOTO - TYPE C

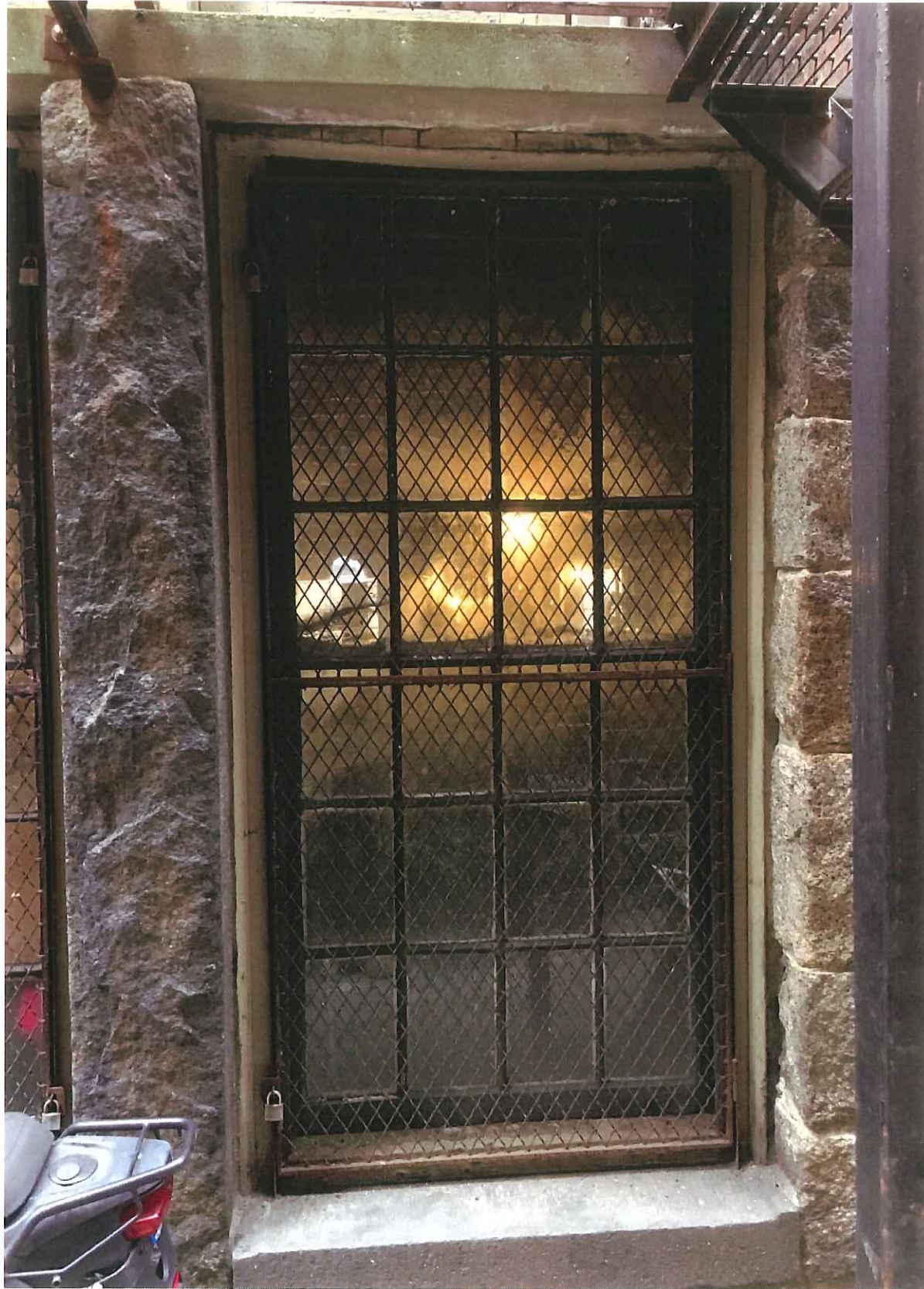

EXISTING WINDOW - TYPE C

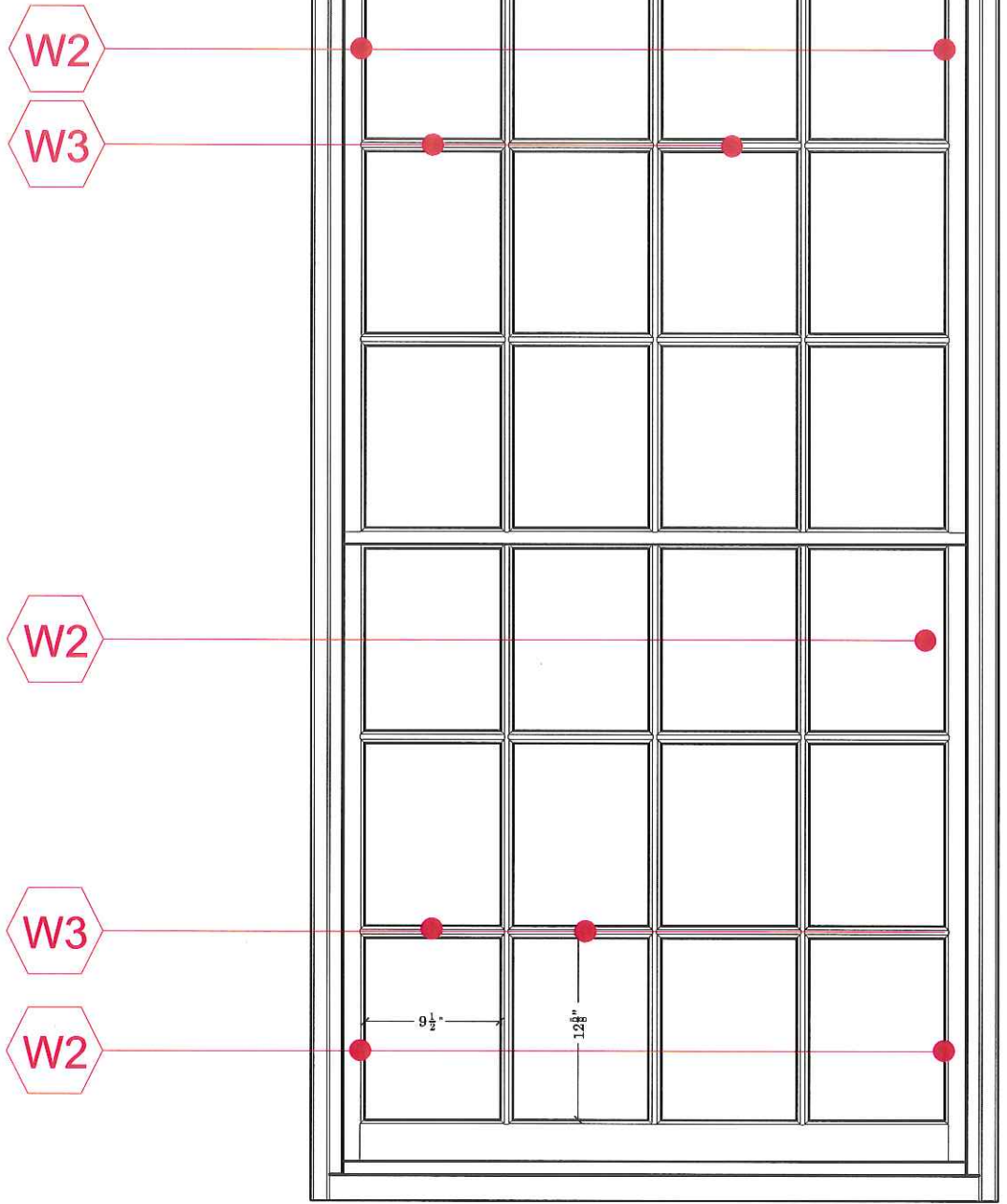

ELEVATION

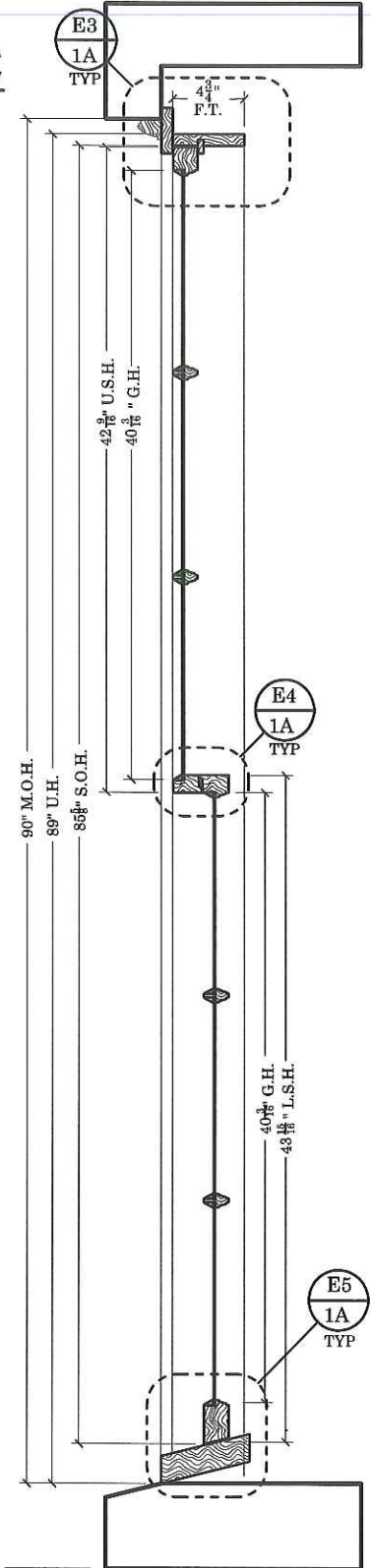

SECTION

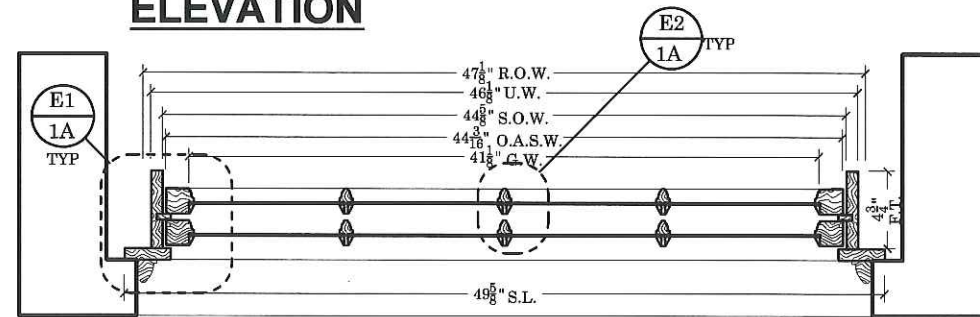

PLAN

48" M.O.W.

EXISTING WINDOW PHOTO - TYPE D

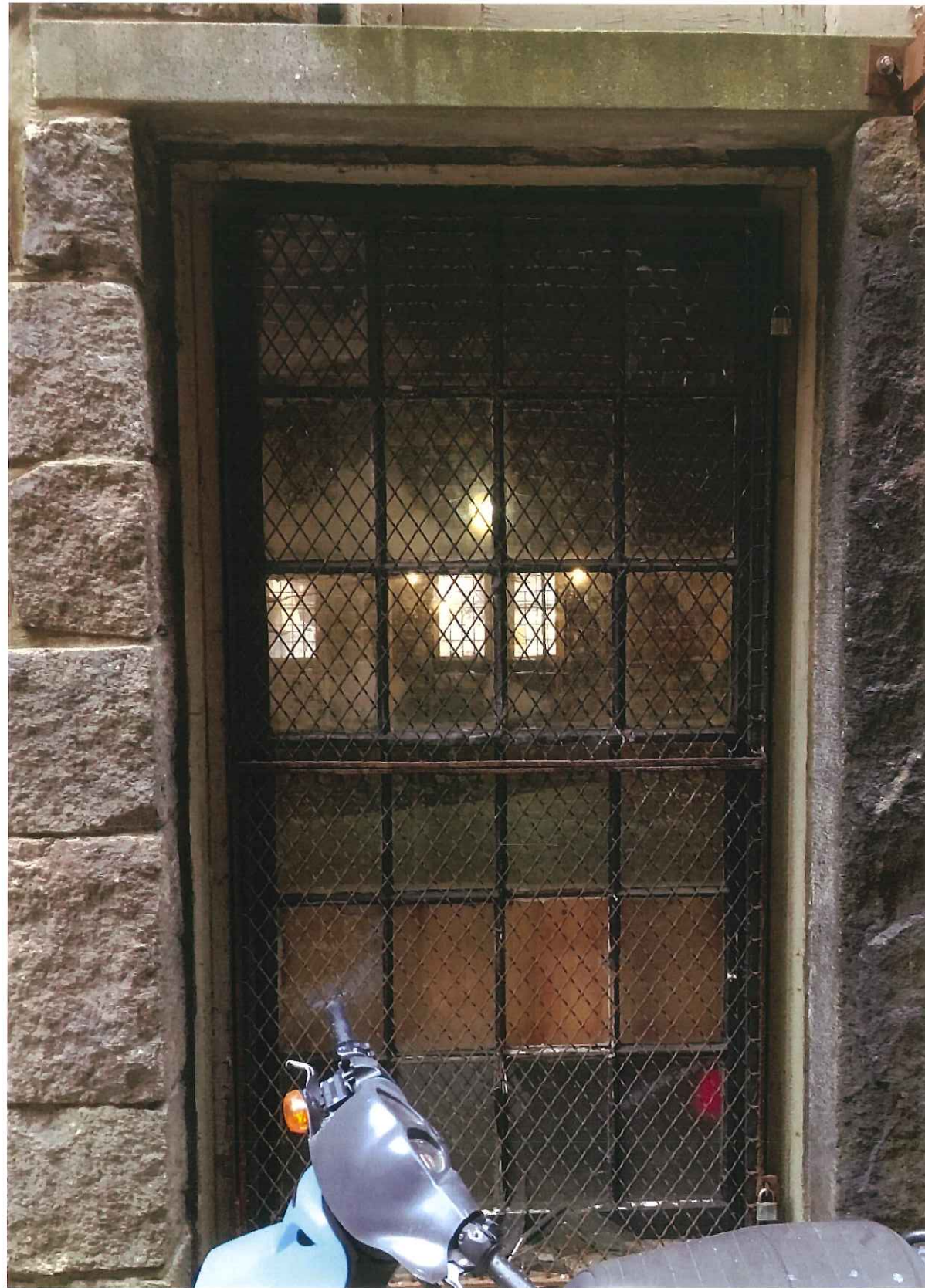

EXISTING WINDOW - TYPE D

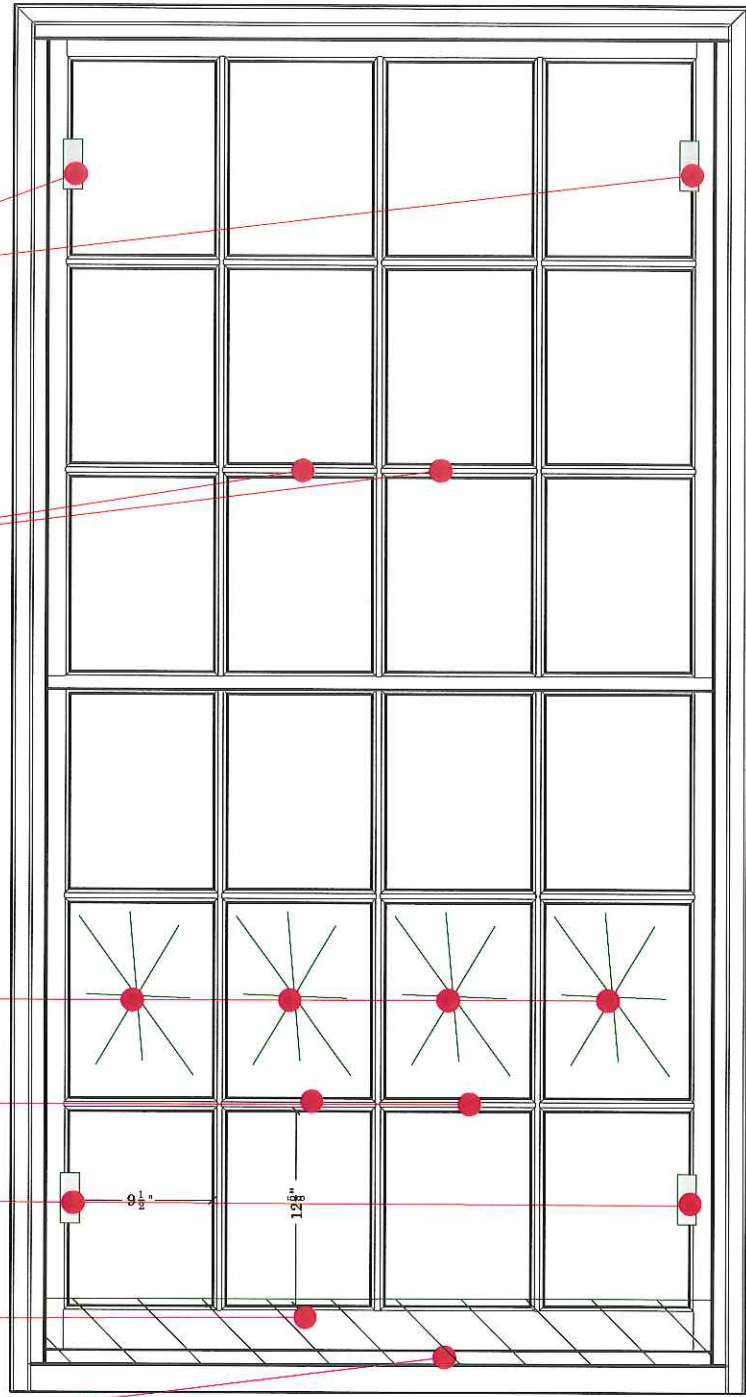

ELEVATION

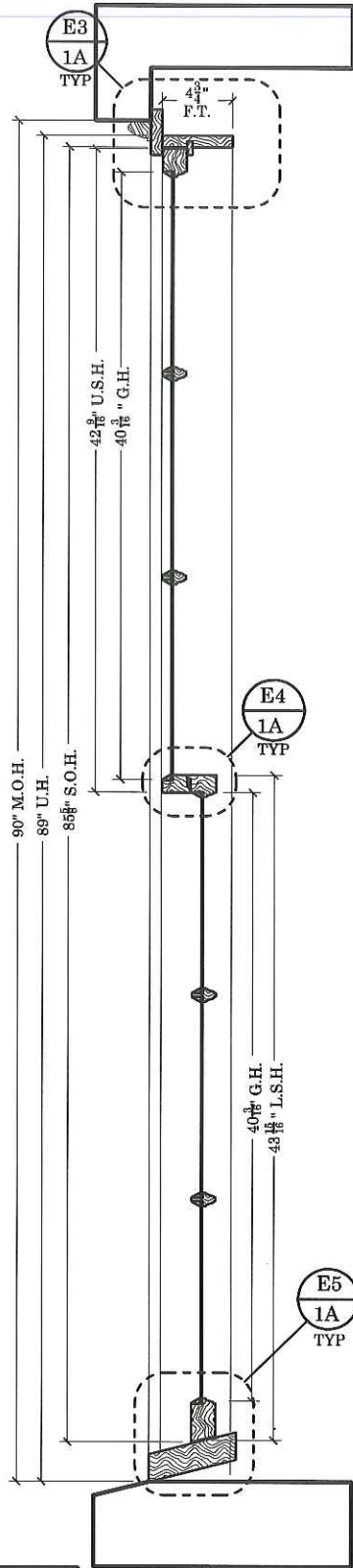

SECTION

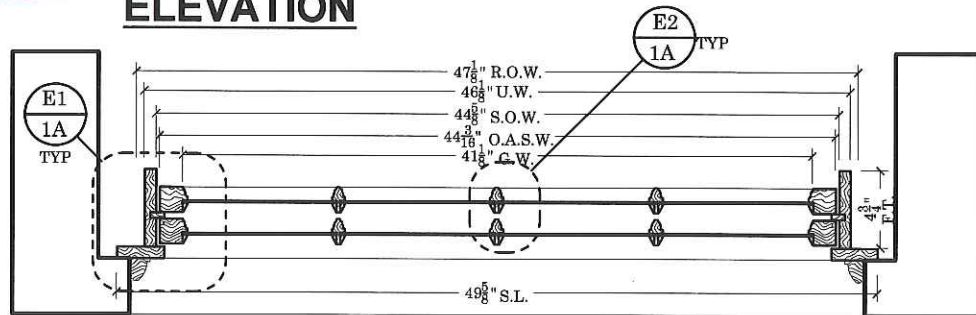

PLAN

48" M.O.W.

EXISTING WINDOW PHOTO - TYPE E

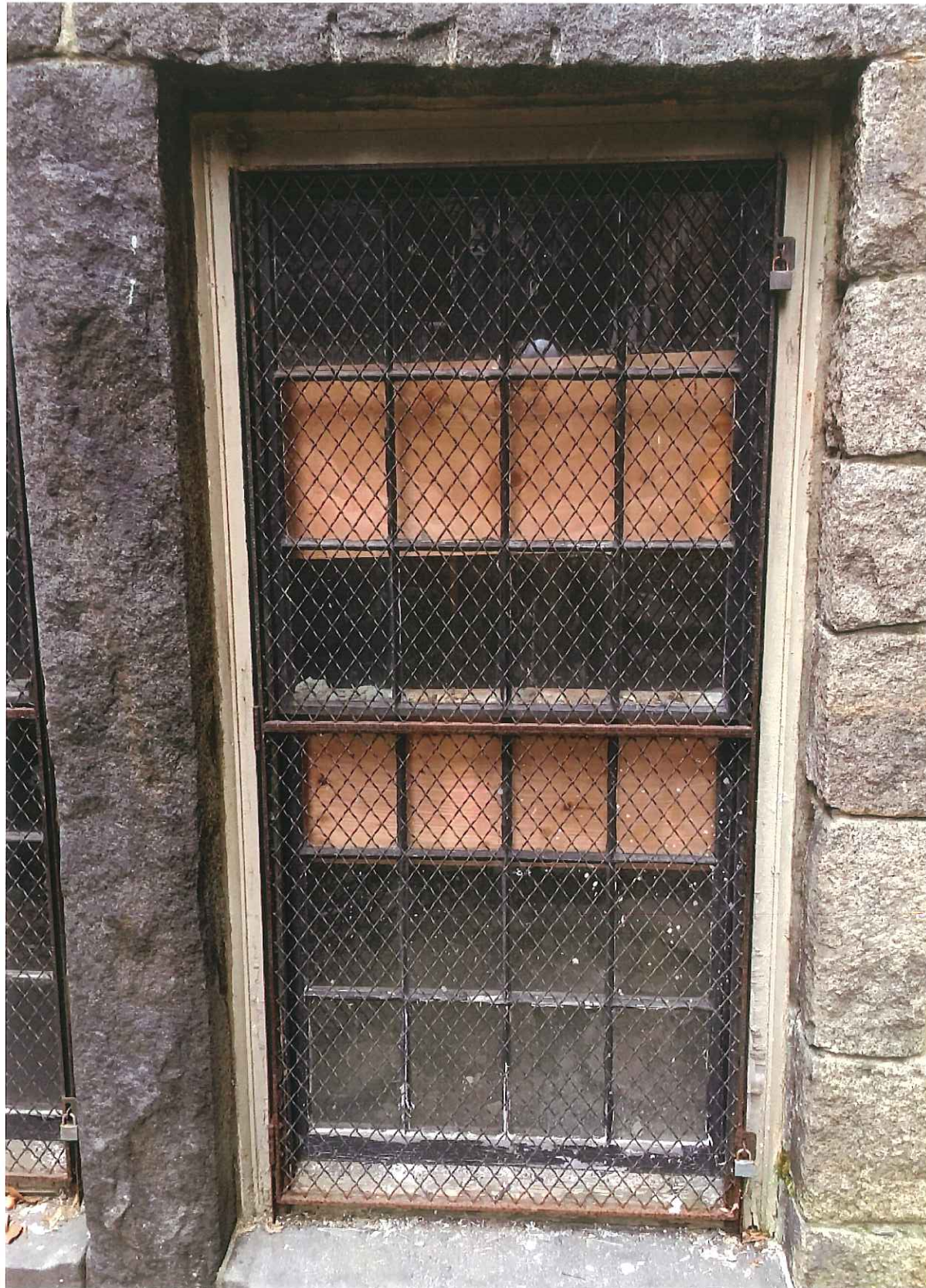

EXISTING WINDOW - TYPE E

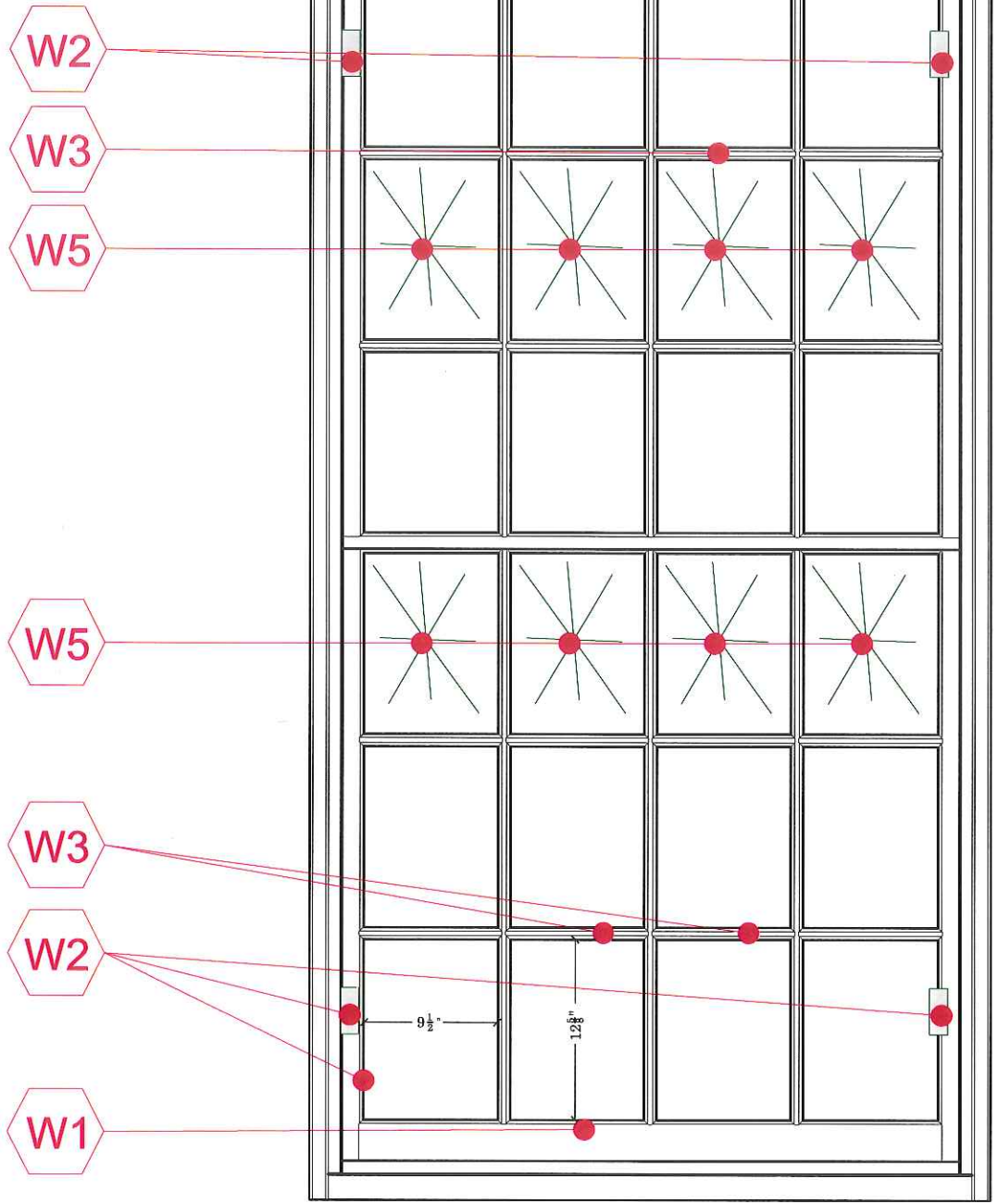

ELEVATION

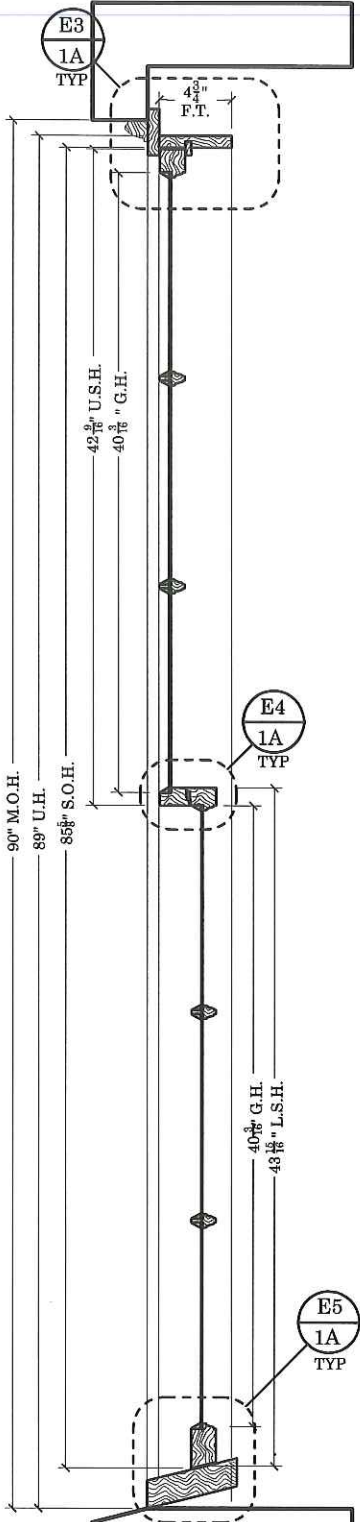

SECTION

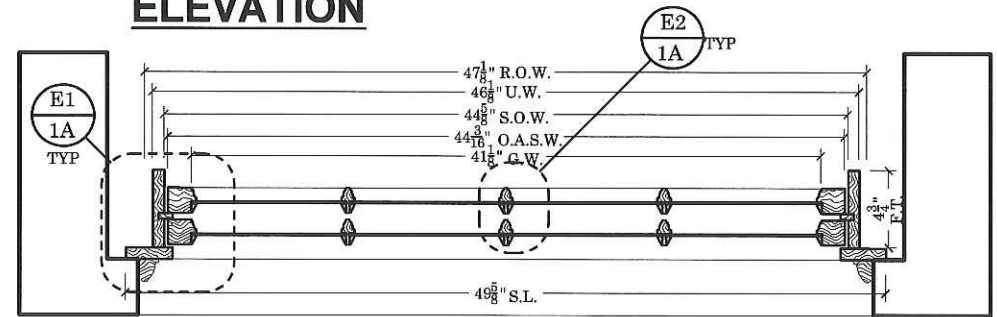

PLAN



1. East elevation, view west from Bowdoin Street

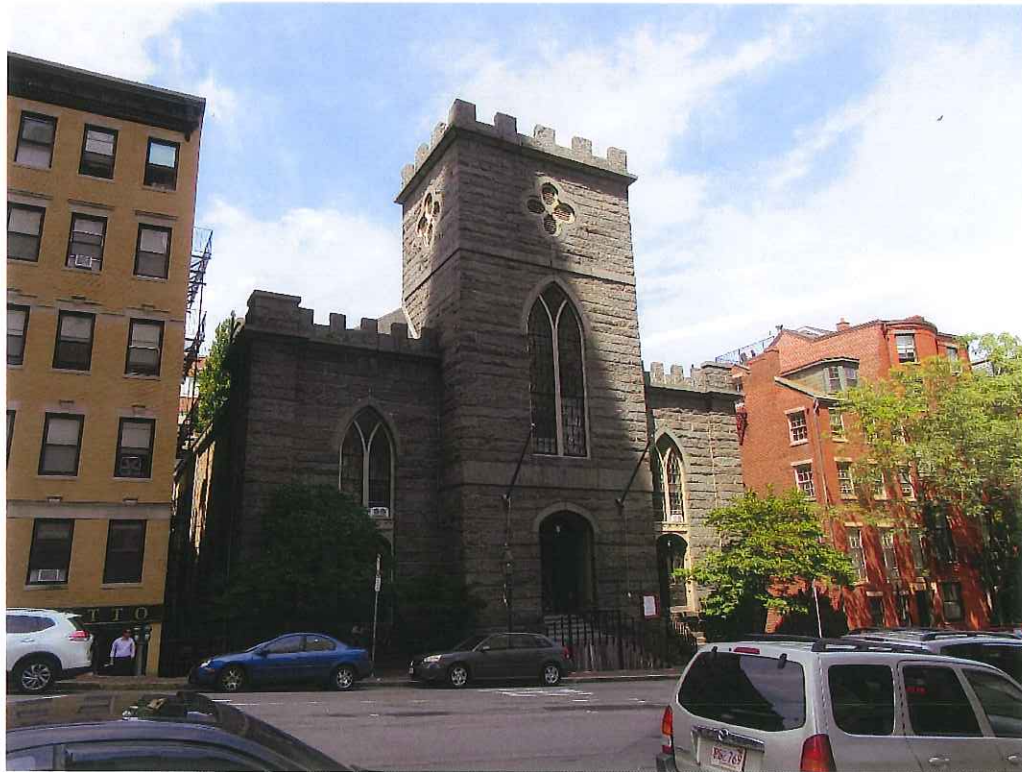

2. East elevation, view northwest from Bowdoin Street



3. South elevation, view west from public sidewalk



4. South elevation, view west with location of new gas meters and enclosure at far right



5. South elevation window, typical condition



6. South elevation window, typical condition



7. South elevation window, typical condition



8. South elevation window, typical condition

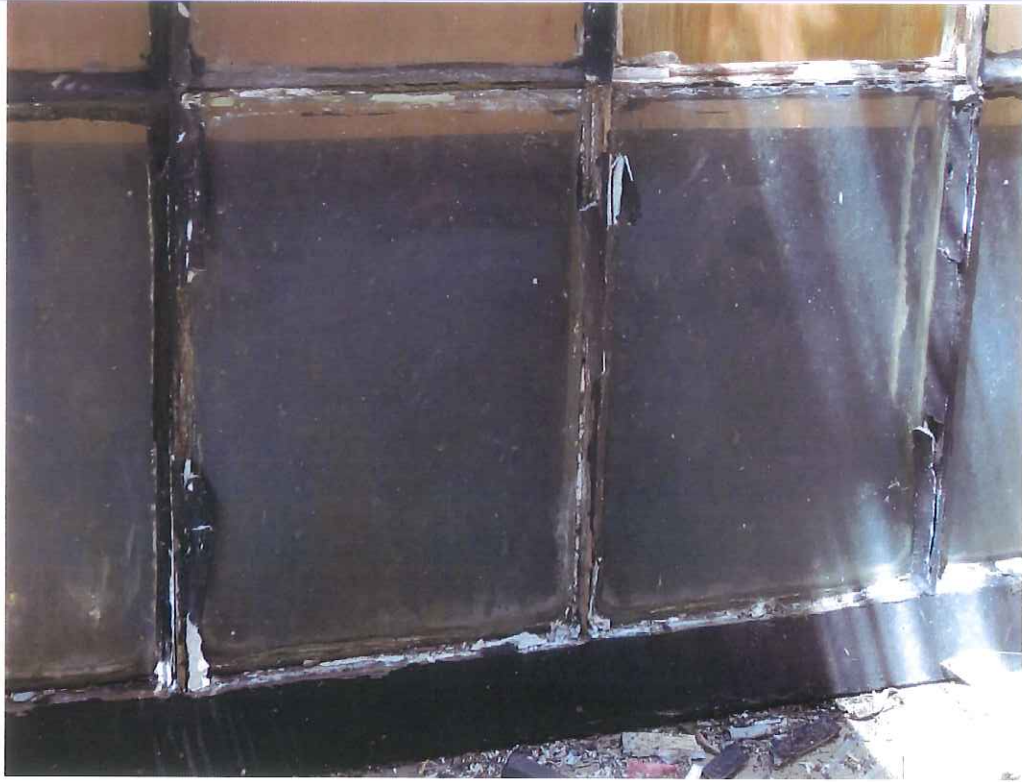

9. South elevation window, typical condition



10. South elevation window, typical condition



11. South elevation window, typical condition



12. South elevation window, typical condition



13. South elevation window, typical condition



14. South elevation window, typical condition

Updated Elevation Drawing

Existing South Elevation



Proposed Door Details

TYPICAL NEW UNIT DOOR TYPE

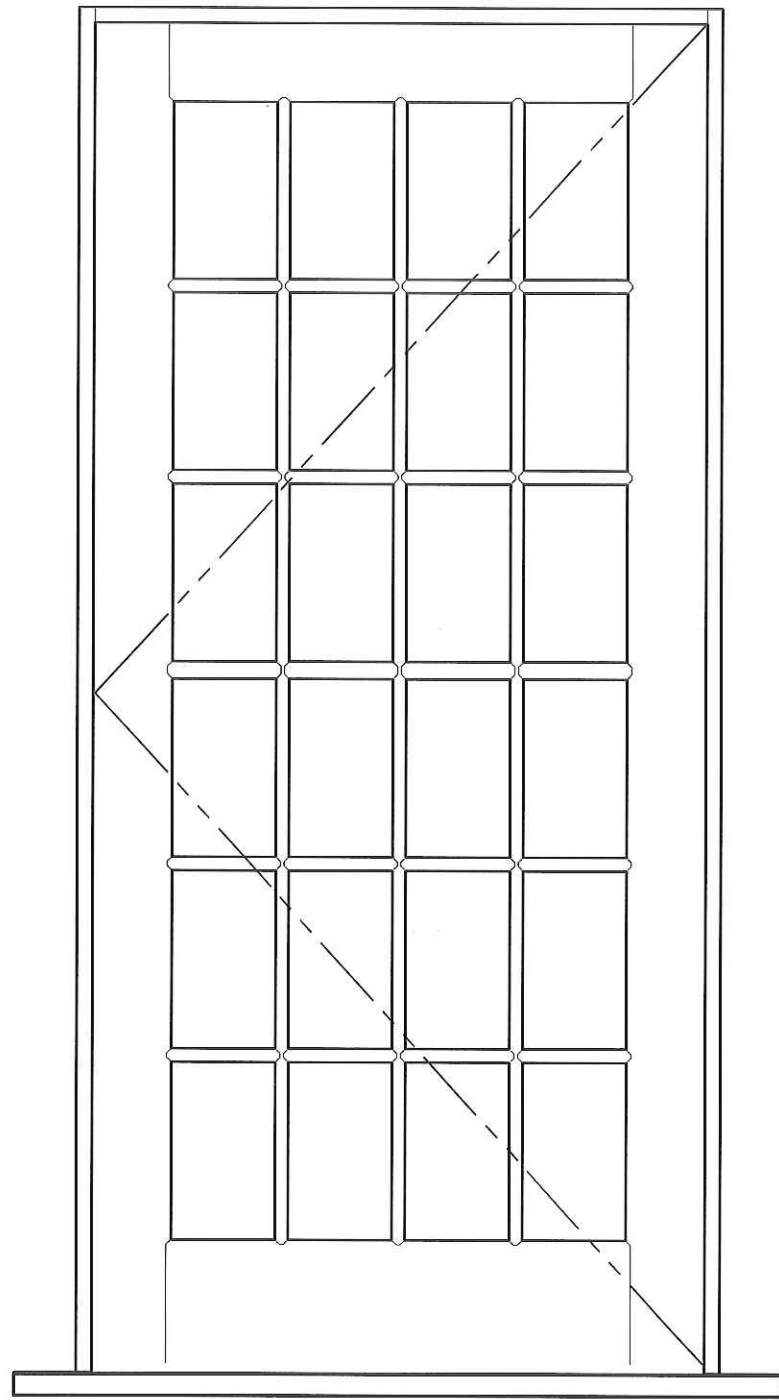

ELEVATION

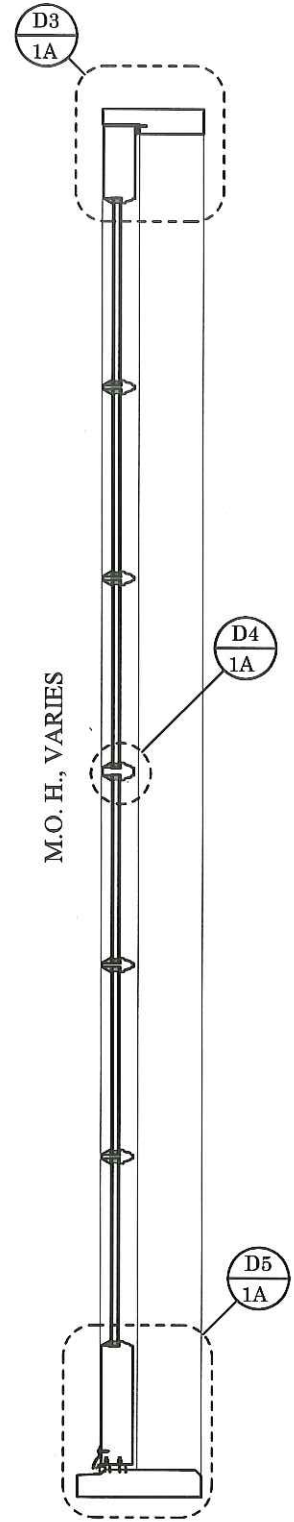

SECTION

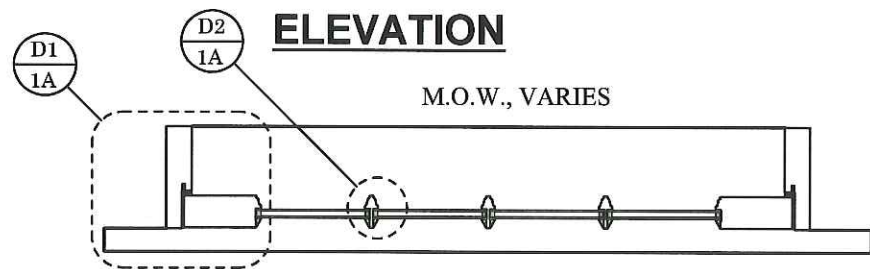

PLAN

EXISTING WINDOW DETAILS

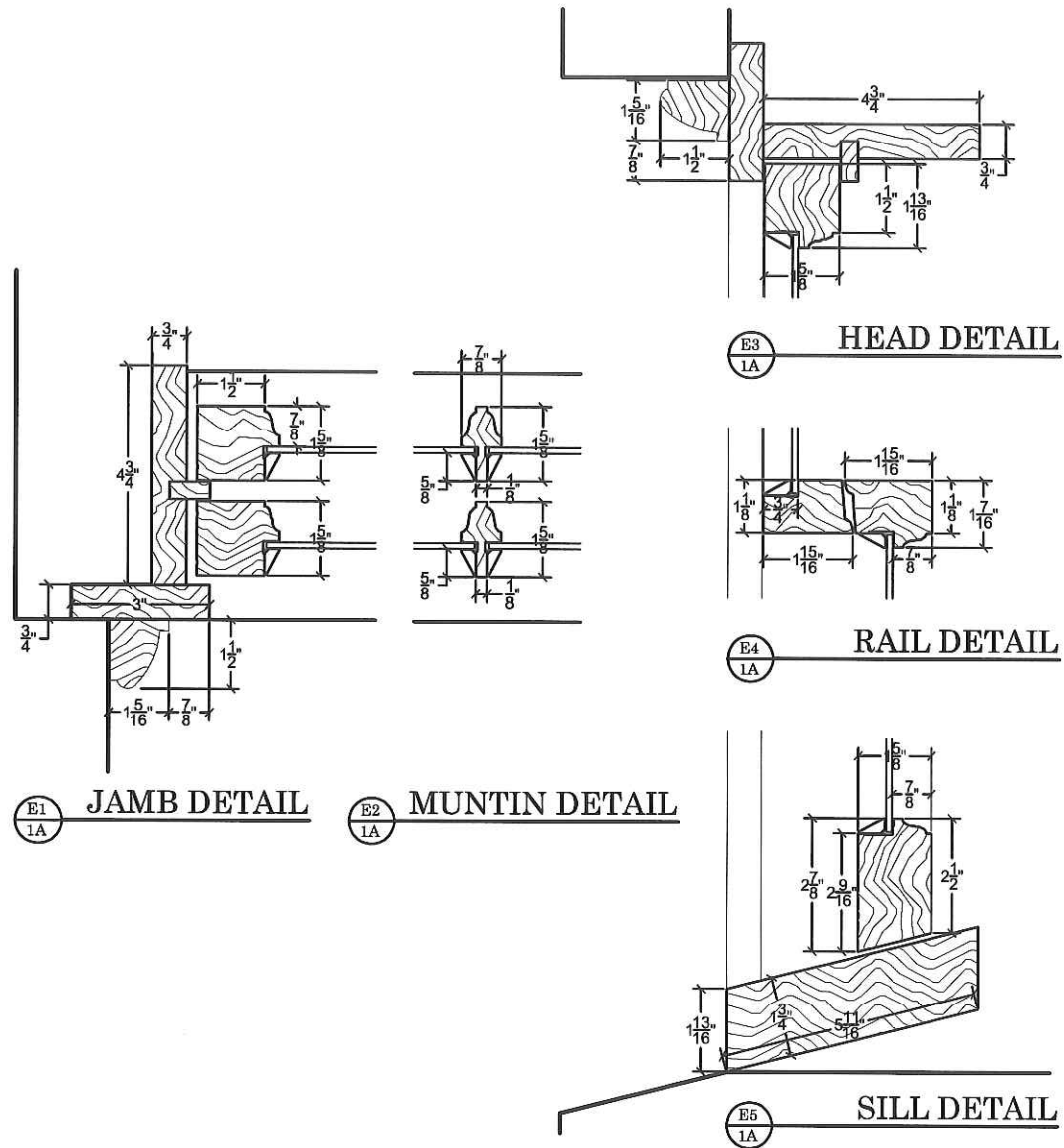

NEW DOOR DETAILS

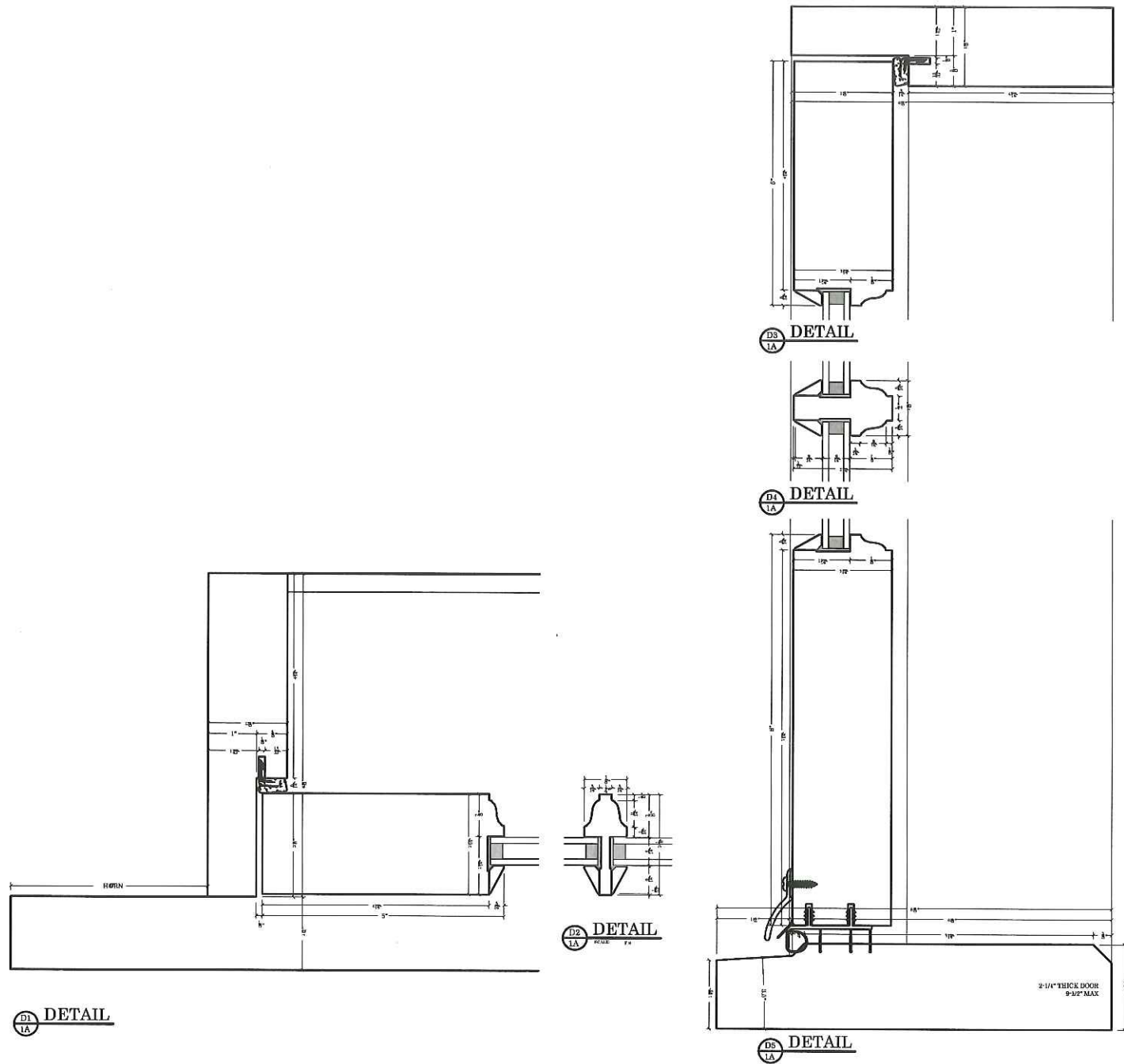

Comparative Window Drawings

EXISTING WINDOW DETAILS

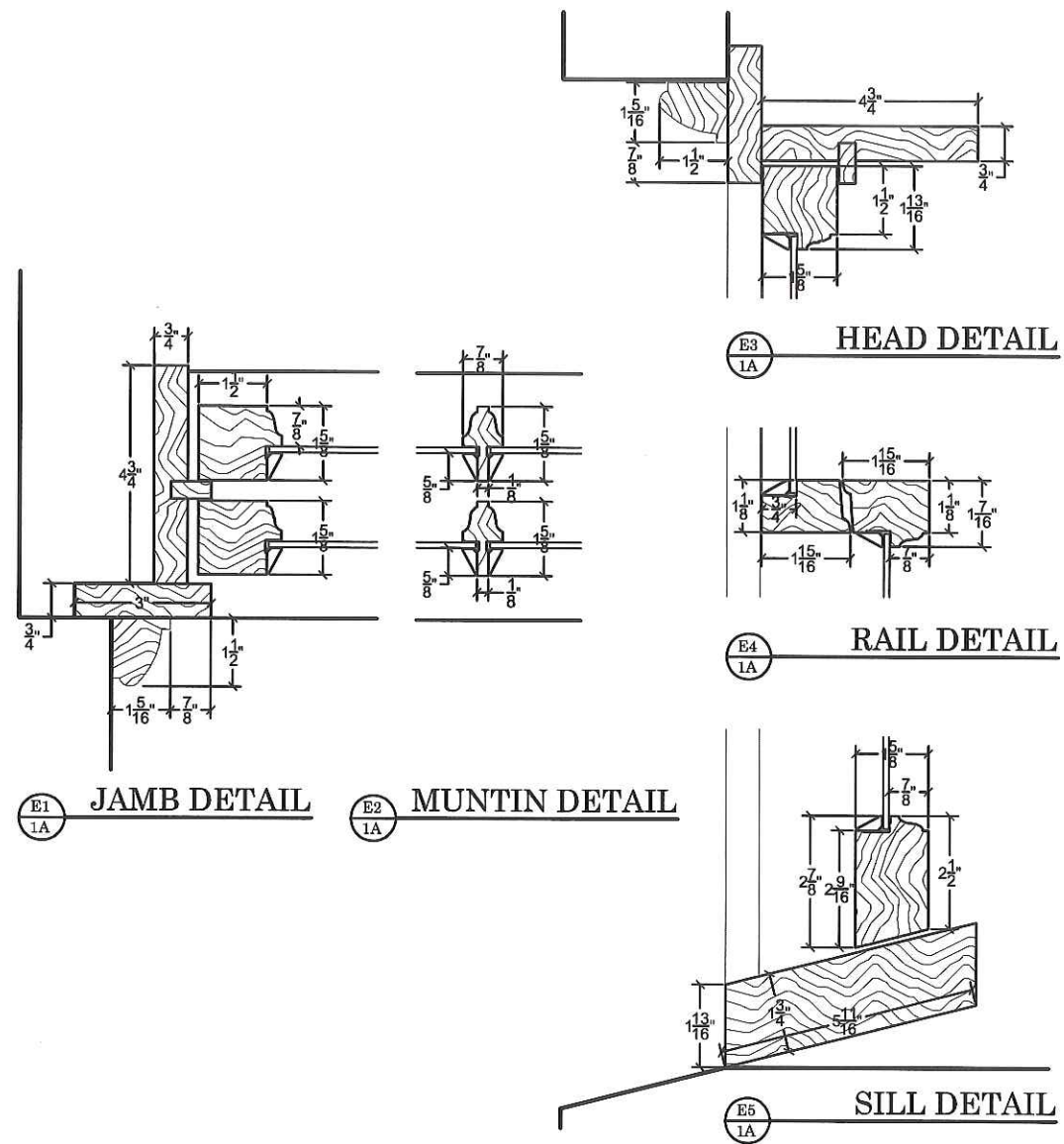

TYPICAL EXISTING WINDOW TYPE REPLACED W/ NEW UNIT DOORS

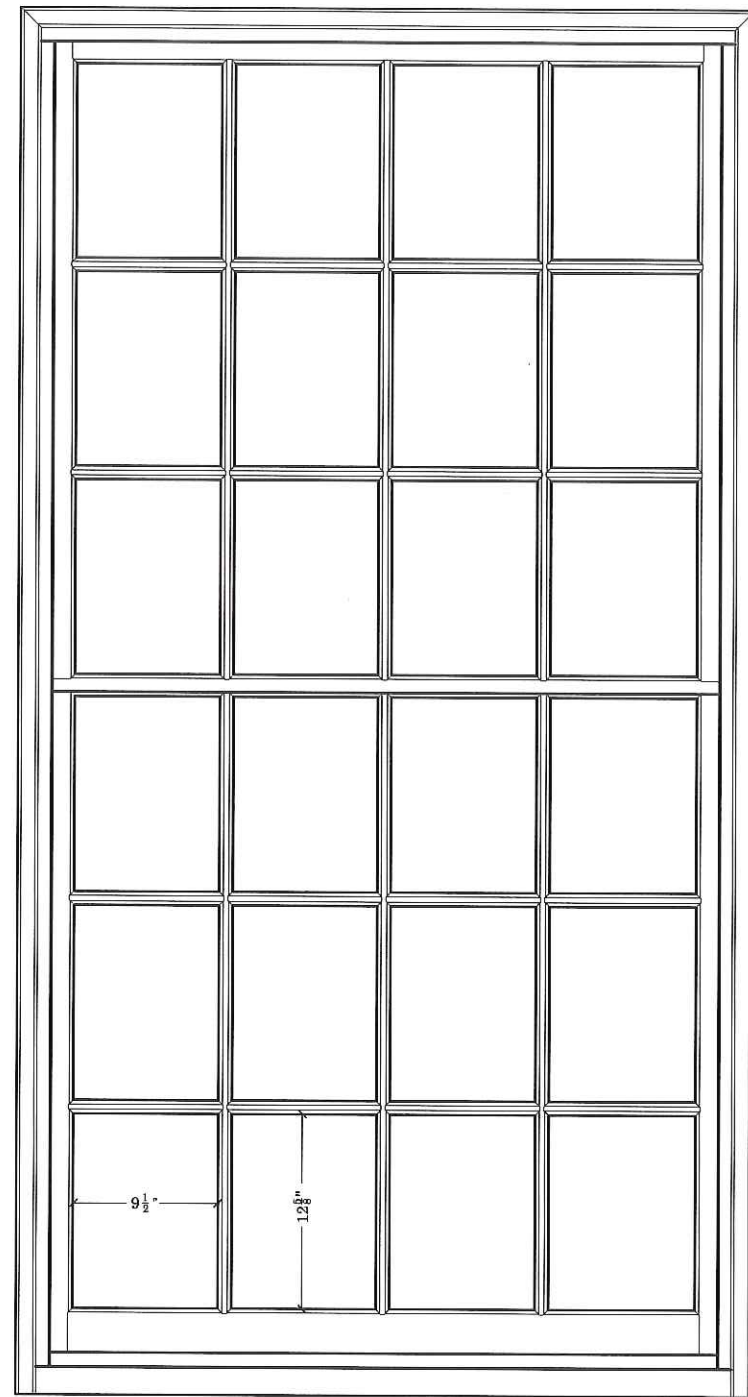

ELEVATION

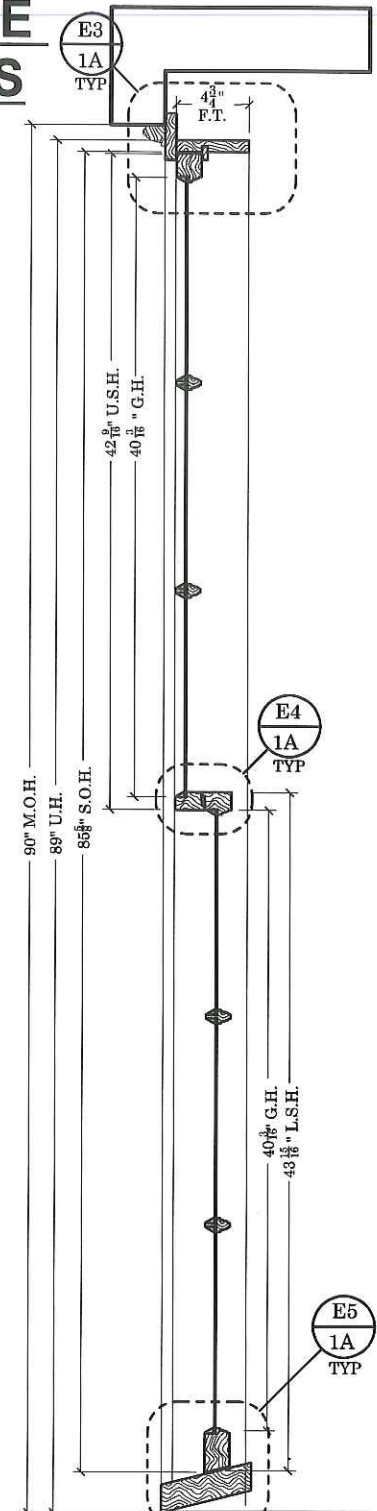

SECTION

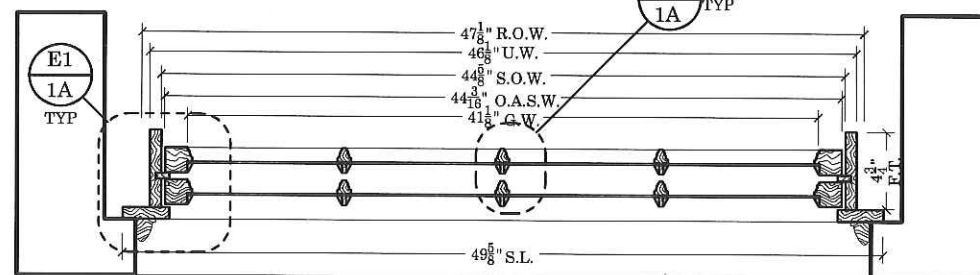

PLAN

48" M.O.W.

Existing South Elevation

