

| Rack ID | Parcel Location | Work | Notes |
|----------------|--|------------------|---|
| 2181 | Rutland Square @ Columbus Avenue | New Installation | Requested by neighborhood to discourage cyclists who are utilizing park space from afixing bicycles to private fencing. |
| 2182 | West Rutland Square @ Titus Sparrow Park Courts | New Installation | Requested by neighborhood to discourage cyclists who are utilizing park space from afixing bicycles to private fencing. |
| 2183 | West Rutland Square @ Titus Sparrow Park Gardens | New Installation | Requested by neighborhood to discourage cyclists who are utilizing park space from afixing bicycles to private fencing. |

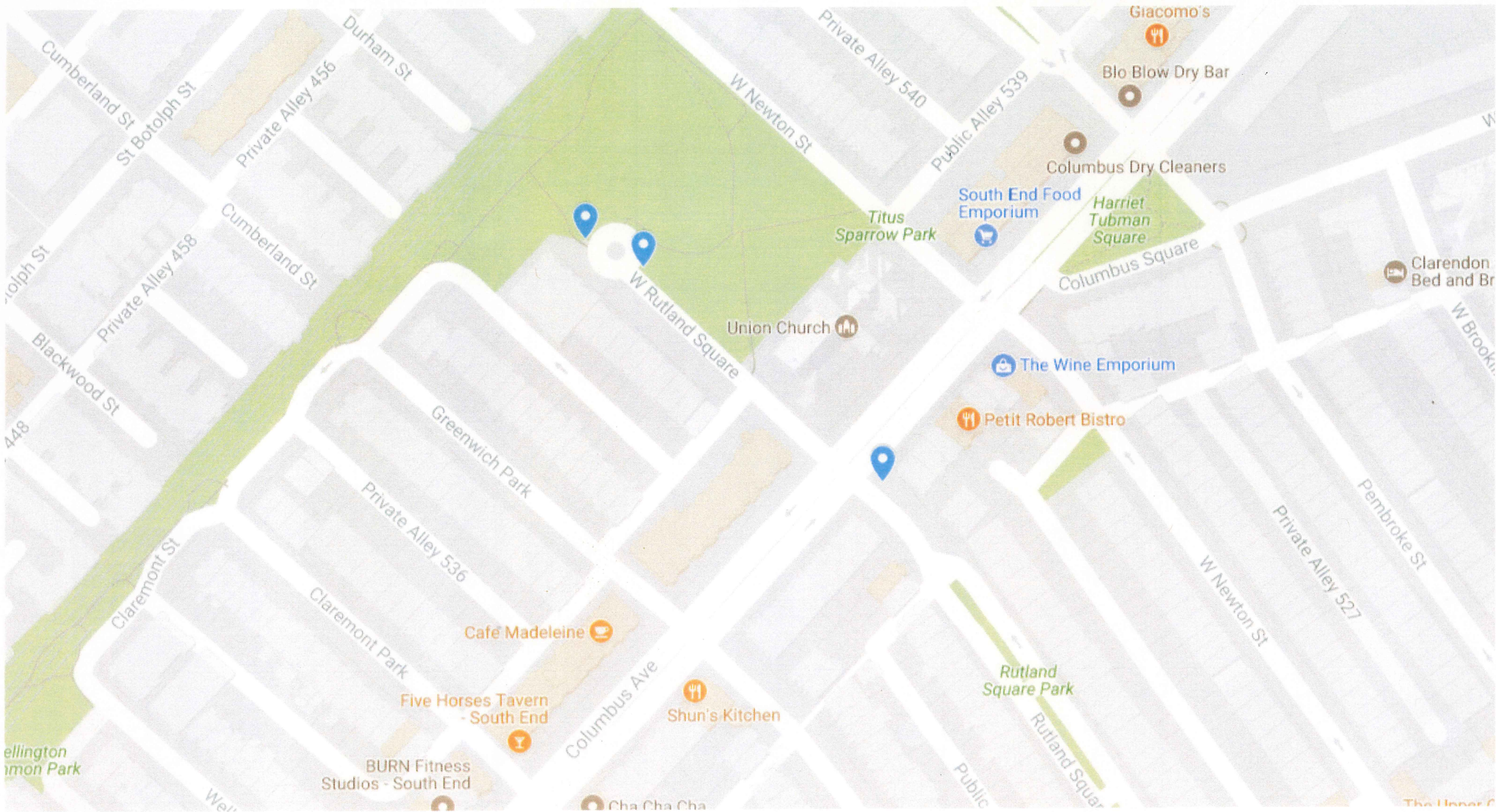

BIKE HITCH

Submittal Sheet

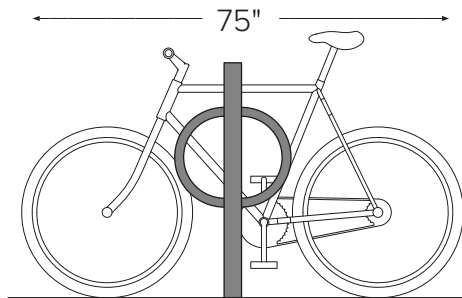
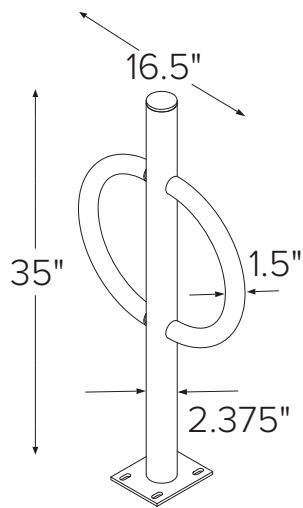

CAPACITY 2 Bikes

MATERIALS Centerbeam: 2" schedule 40 pipe (2.375" OD)
Ring: 1.5" OD 11 gauge tube

FINISHES

- Galvanized**
An after fabrication hot dipped galvanized finish is our standard option.
- Powder Coat**
Our powder coat finish assures a high level of adhesion and durability by following these steps:
1. Sandblast
2. Epoxy primer electrostatically applied
3. Final thick TGIC polyester powder coat

- Thermoplastic**
In addition to an increased thickness (8-10mils), the thermoplastic finish covers a galvanized layer and offers superior impact resistance over powder coating.

- PVC Dip (plastisol)**
Other colors available by special order (minimum orders apply)

- Stainless**
Stainless Steel: 304 grade stainless steel material finished in either a high polished shine or a satin finish.

MOUNT OPTIONS

- In-ground**
In ground mount is embedded into concrete base. Specify in ground mount for this option.

- Surface**
Foot Mount has a 5"x6"x.25" foot with four anchors per foot. Specify foot mount for this option.

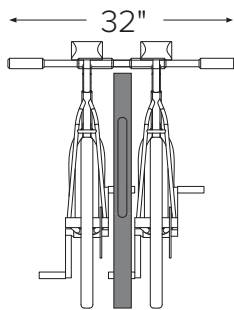

DERO
A PLAYCORE Company

www.dero.com | 1-888-337-6729

BIKE HITCH

Installation Instructions – In Ground Mount

TOOLS NEEDED

Level
Cement mixing tub
Shovel
Trowel

Hole coring machine with 4" bit
Access to water hose
Materials to build brace (see "Install Tip" at bottom of page)

INSTALLING INTO EXISTING SIDEWALK

Core holes no less than 3" diameter (4" recommended) and 10" deep into sidewalk. Fill holes with Por-Rok or epoxy grout. Place rack into holes, making sure the rack is level. 33"-36" of the rack should remain above the surface. If the rack is less than 33" high, it will not support the bike adequately. Make sure the rack is level and held in place until the grout has set.

INSTALLING INTO A NEW SIDEWALK

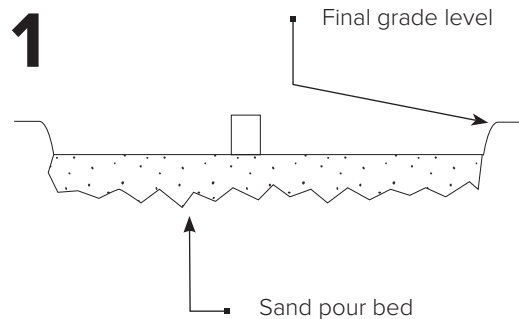

Place corrosion resistant sleeve (min. 3" inside diameter) in sand pour bed in exact location where rack will be installed. Make sure top of sleeve is at same level as desired finished concrete surface. Fill sleeve with sand to keep it in place and prevent it from filling with concrete.

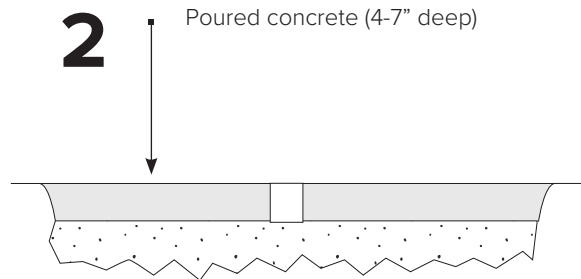

Pour concrete and allow to cure.

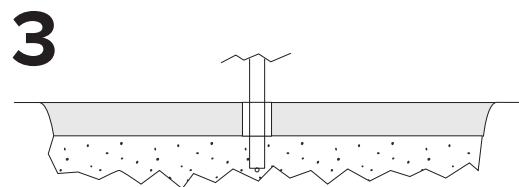

After appropriate cure time, dig out sand from sleeves and insert racks, making sure they are level and at the appropriate height. Pour in Por-Rok or epoxy grout and allow to set.

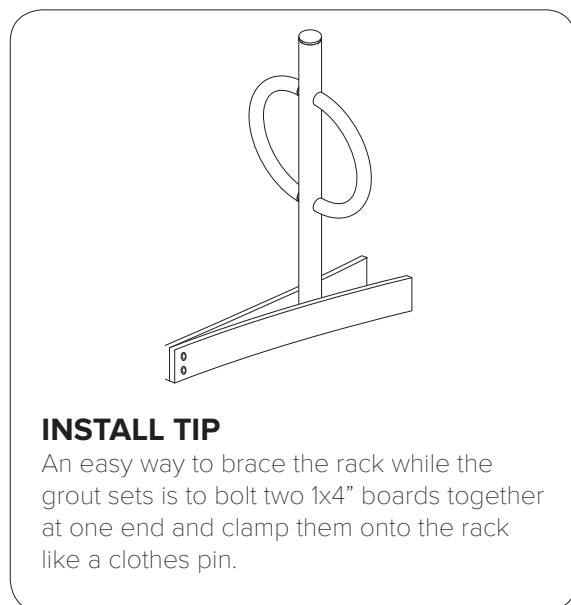

DERO
A PLAYCORE Company

www.dero.com | 1-888-337-6729

CITY OF BOSTON BIKE RACK FIELD SHEET & APPROVAL FORM

ID #2181

SITE INFORMATION

ADDRESS: Rutland Square @ Columbus Avenue

NUMBER OF RACKS: 1

INSTALL TYPE: Inground

CROSS STREET: Columbus Avenue

RACK TYPE: Single

SPECIFIC SITE:

NEIGHBORHOOD/ZIP: South End, 02118

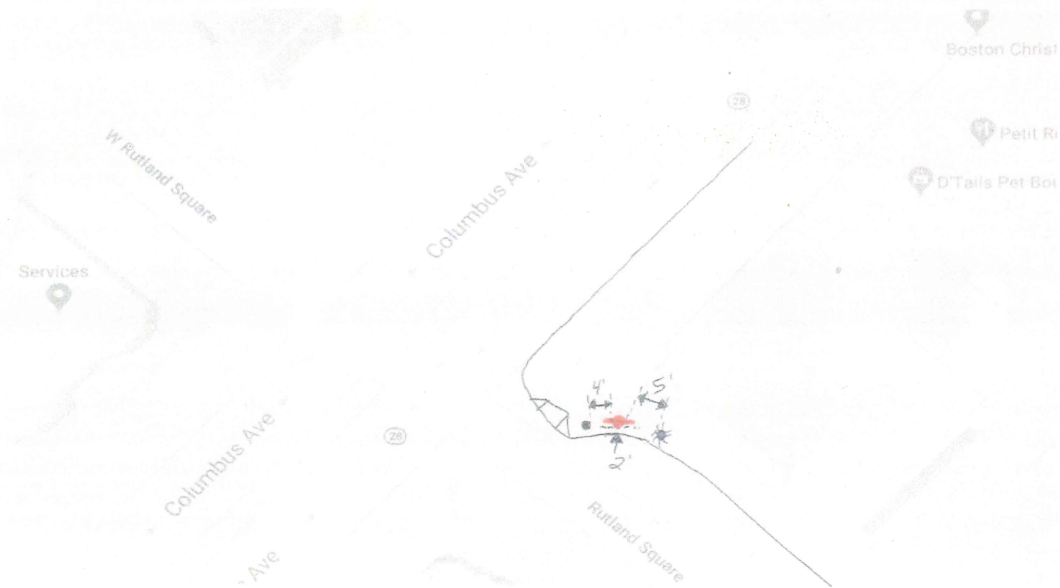

NOTES FOR CONTRACTOR

Rack to be installed parallel to curb, and at least 24" from edge of curb. Orientation line has been provided. Maintain at least 4' from sign post and at least 5' from street light.



CITY OF BOSTON BIKE RACK FIELD SHEET & APPROVAL FORM

ID #2182

SITE INFORMATION

ADDRESS: West Rutland Square (circle) @ Titus Sparrow Park

NUMBER OF RACKS: 1

INSTALL TYPE: Inground

CROSS STREET: _____

RACK TYPE: Single

SPECIFIC SITE: Basketball Courts

NEIGHBORHOOD/ZIP: South End, 02118

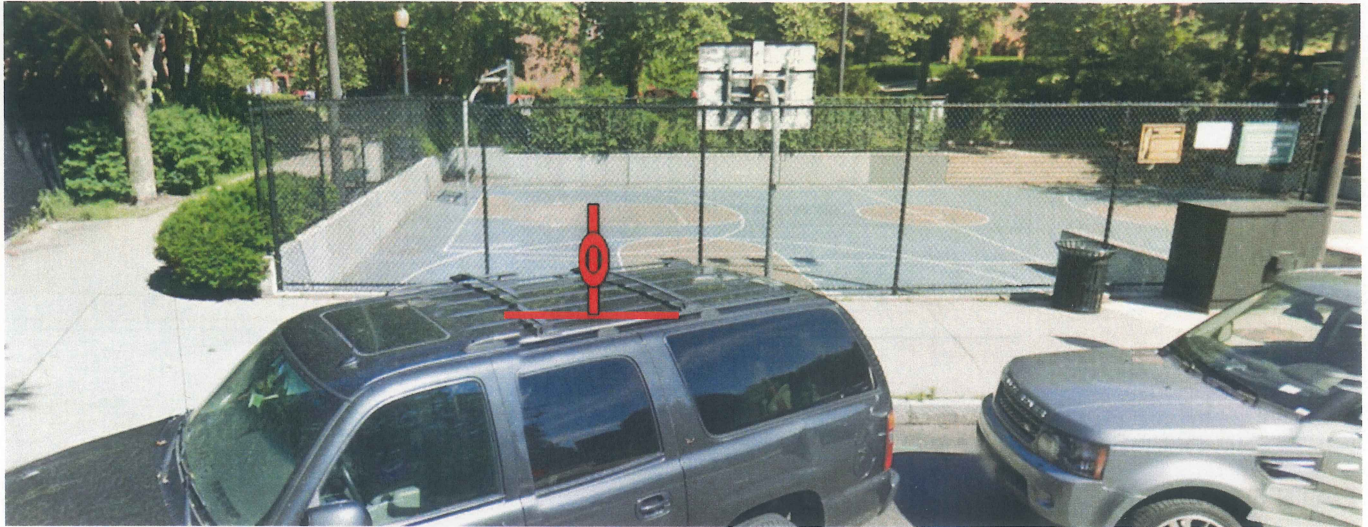

NOTES FOR CONTRACTOR

Rack to be installed parallel to fence, and centered at the fence panel. Rack should be installed at least 24" from fence. Orientation line has been provided.



City of Boston | Martin J. Walsh, Mayor
Boston Transportation Department | Gina N. Fiandaca, Commissioner



CITY OF BOSTON BIKE RACK FIELD SHEET & APPROVAL FORM

ID #2183

SITE INFORMATION

ADDRESS: West Rutland Square (circle) @ Titus Sparrow Park

CROSS STREET: _____

SPECIFIC SITE: Near Gardens

NEIGHBORHOOD/ZIP: South End, 02118

NUMBER OF RACKS: 1

INSTALL TYPE: Inground

RACK TYPE: Single

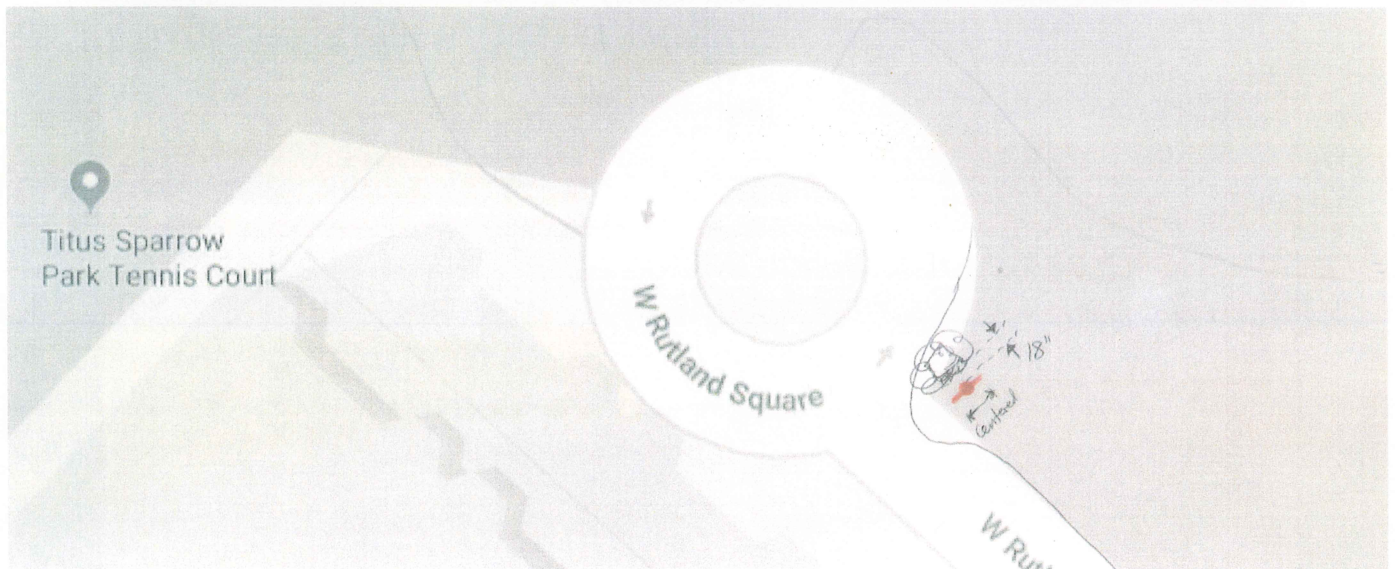

NOTES FOR CONTRACTOR

Rack to be installed centered on tree, and at least 18" from edge of ornamental stones.

