

THE FIRST CHURCH OF CHRIST, SCIENTIST  
PLAZA RESTORATION AND REPAIR PROJECT  
**BLC DESIGN REVIEW MEETING SIX - DRAFT**  
MAY 2, 2017

# REVIEW ITEMS FOR APPROVAL

MAY 23rd, 2017 AGENDA

**Review the proposed Massachusetts Avenue Garden concept and address the following BLC comments from the April 12th Site Visit:**

- **Massachusetts Avenue Garden Concept**

- i. Study the floor treatment at the atrium glass wall to strengthen the indoor/outdoor visual connection.
- ii. Consider the viability of using moveable planter pots under the shade of the proposed tree canopy.

- **New Perimeter Wall Design**

- i. Study an intentional reveal to separate the old and new elements of the wall.
- ii. Study the approach from the Clearway Street corner to enhance the existing wall's welcoming function from this direction.
- iii. Consider the use of the stainless steel "slice" to replace the existing granite veneer end detail (from the 2001 substantial alteration) to be more consistent with the new plaza materials palette.
- iv. Study ending the new glass wall "more traditionally" rather than with the proposed signage element.

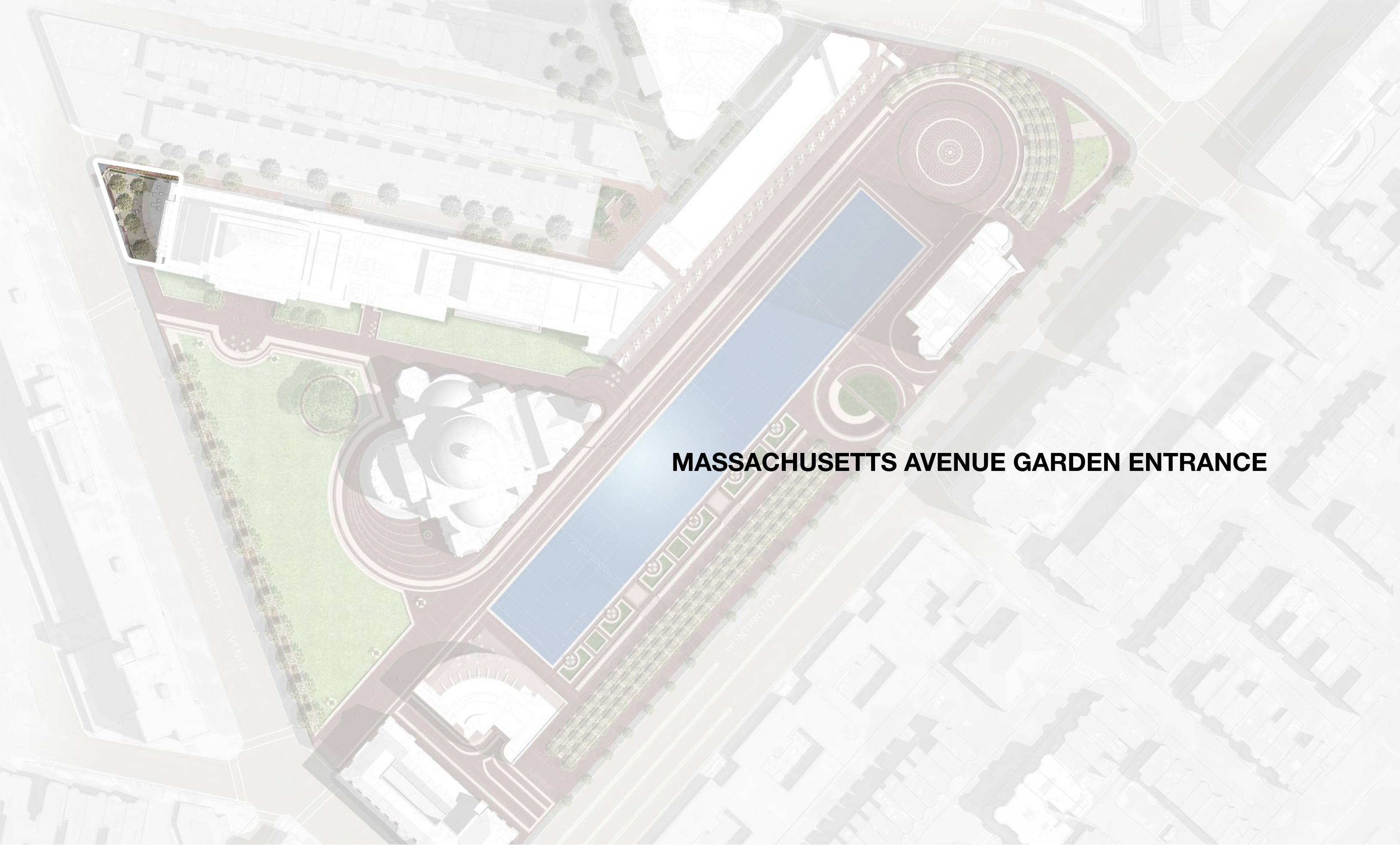

**MASSACHUSETTS AVENUE GARDEN ENTRANCE**

MASSACHUSETTS AVE. GARDEN ENTRANCE  
**ORIGINAL 1934 GARDEN**

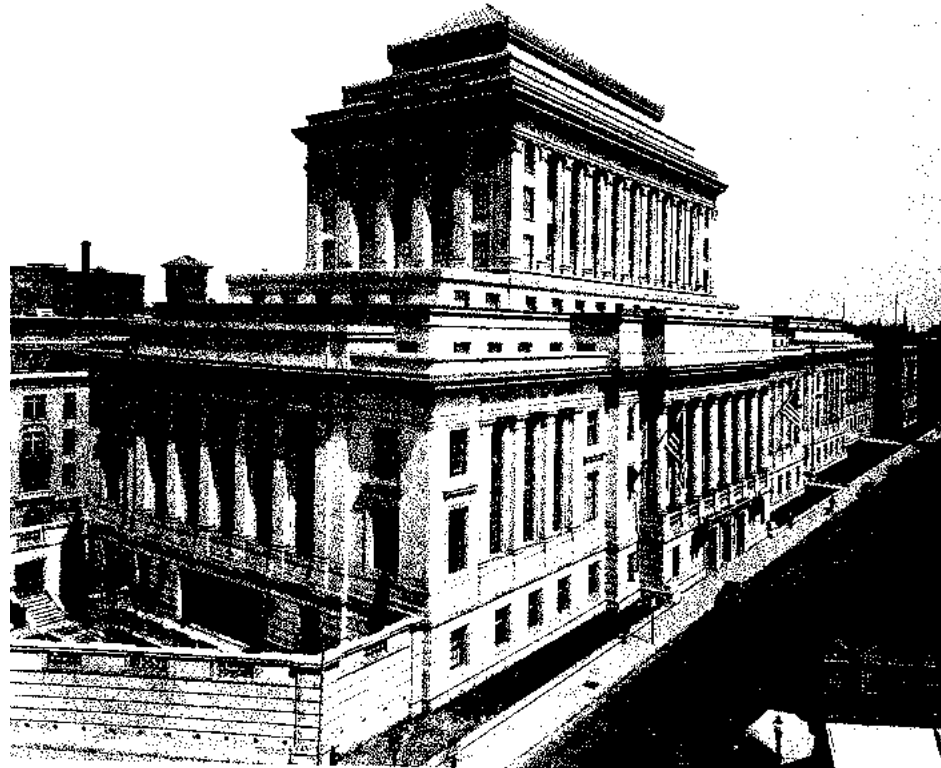
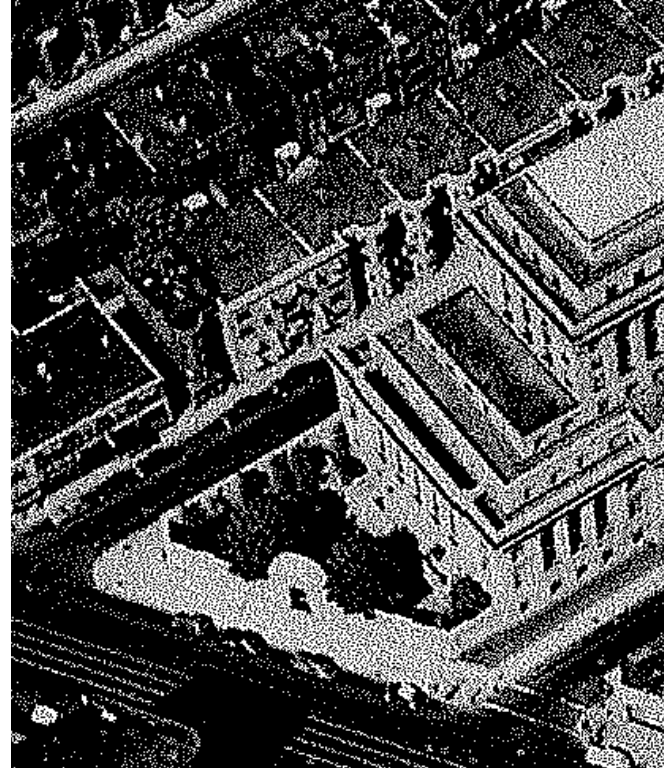
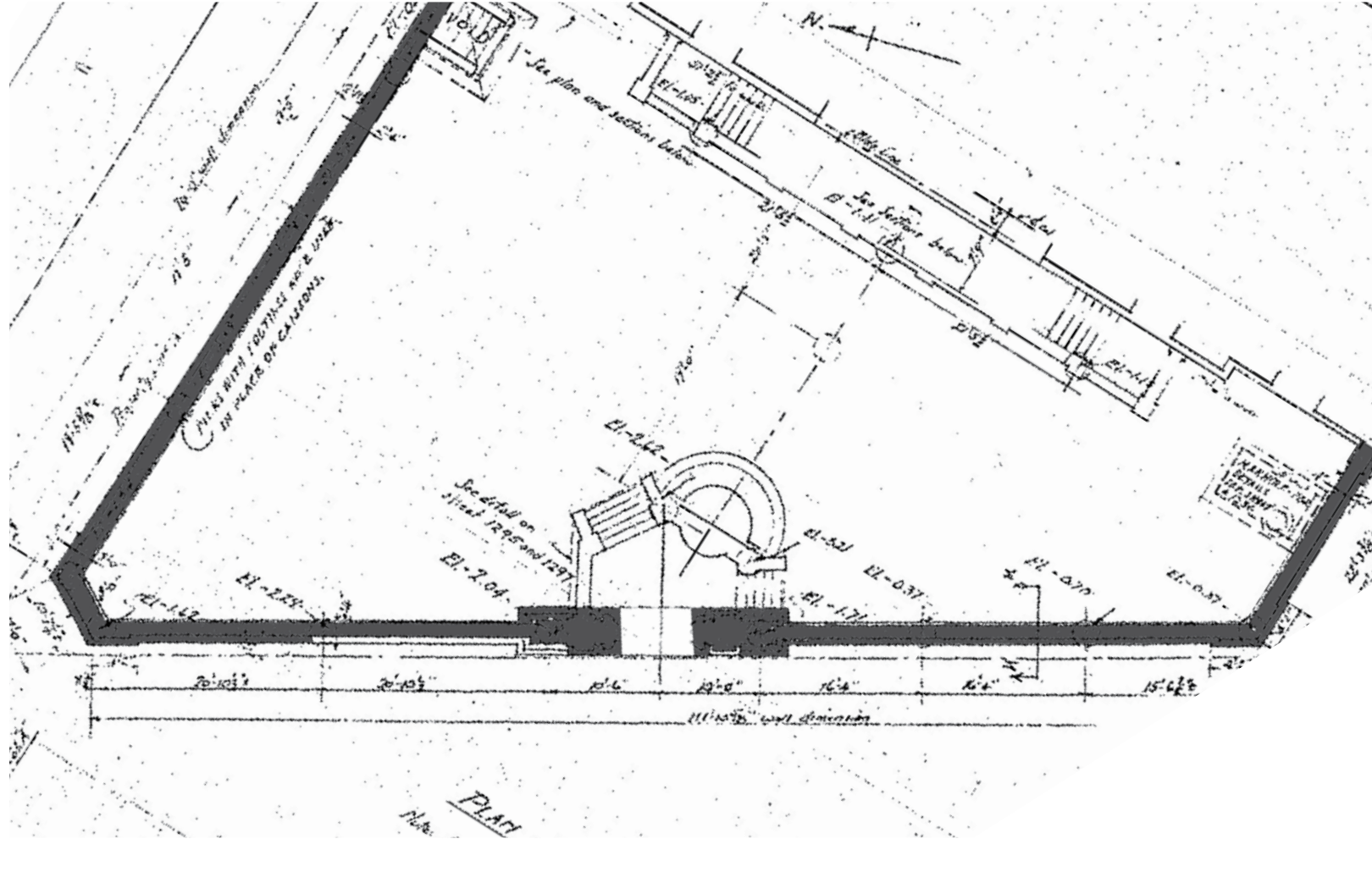

MASSACHUSETTS AVE. GARDEN ENTRANCE  
2001 SUBSTANTIAL ALTERATION

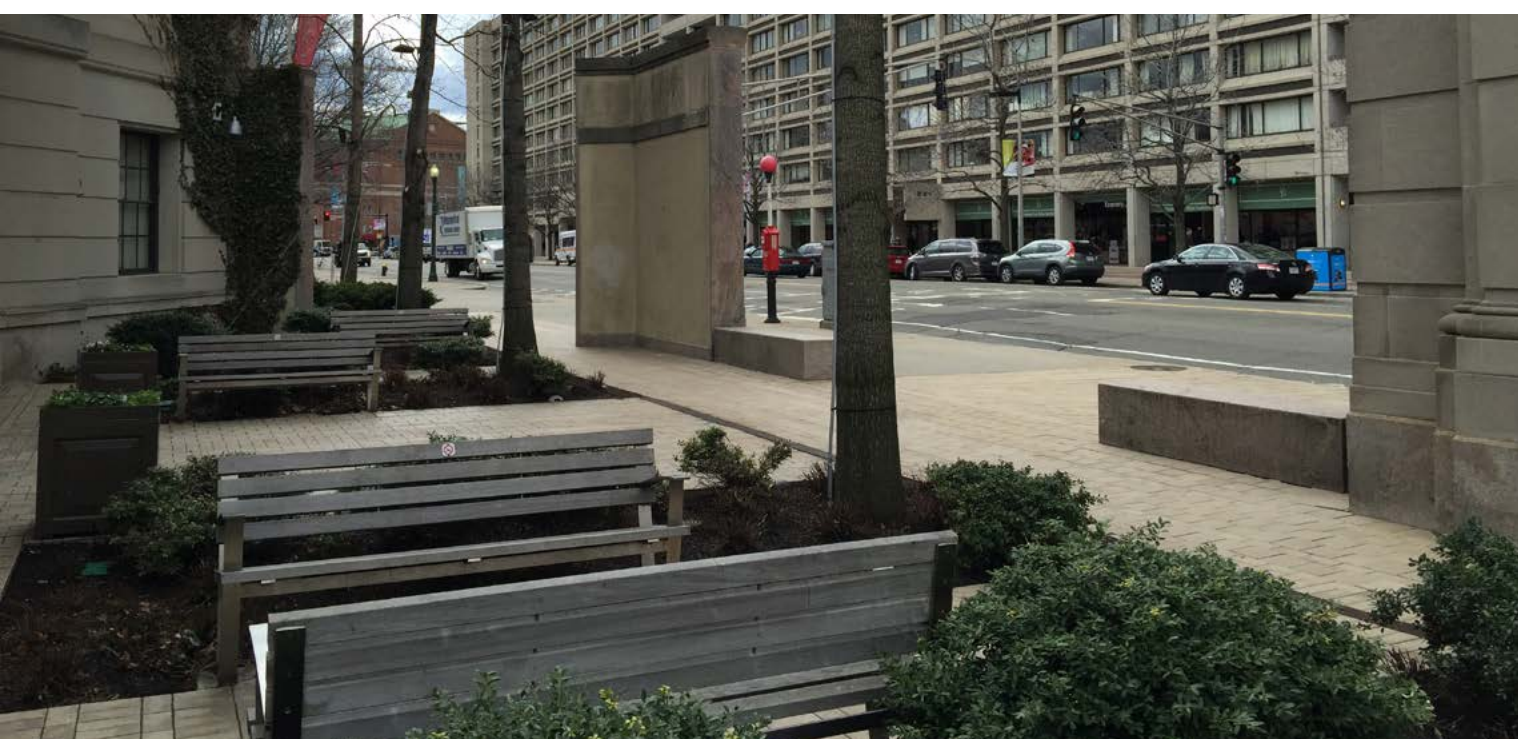

MASSACHUSETTS AVE. GARDEN ENTRANCE  
**2001 SUBSTANTIAL ALTERATION**

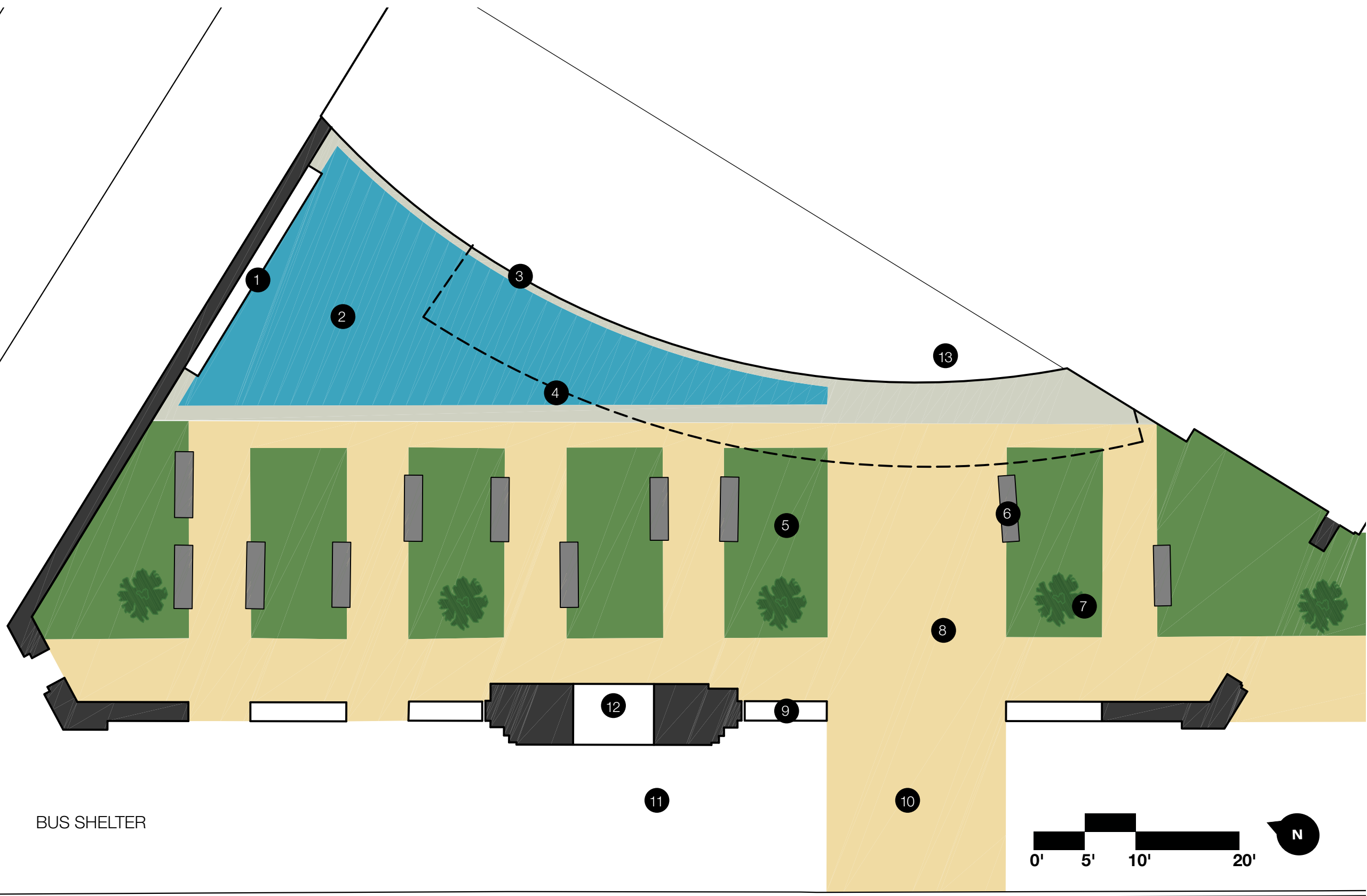

- 1 WATER WALL
- 2 POOL
- 3 GLASS CURTAIN WALL
- 4 OVERHEAD CANOPY
- 5 PLANTING
- 6 BENCH
- 7 SHADE TREE
- 8 TRENCH DRAIN
- 9 GRANITE BENCH
- 10 BRICK PAVING
- 11 CONCRETE SIDEWALK
- 12 EXISTING ARCH
- 13 EXISTING ENTRY DOOR

BUS SHELTER

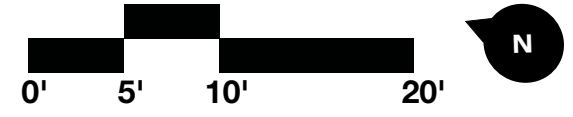

MASSACHUSETTS AVE. GARDEN ENTRANCE  
**PROPOSED PLAN**

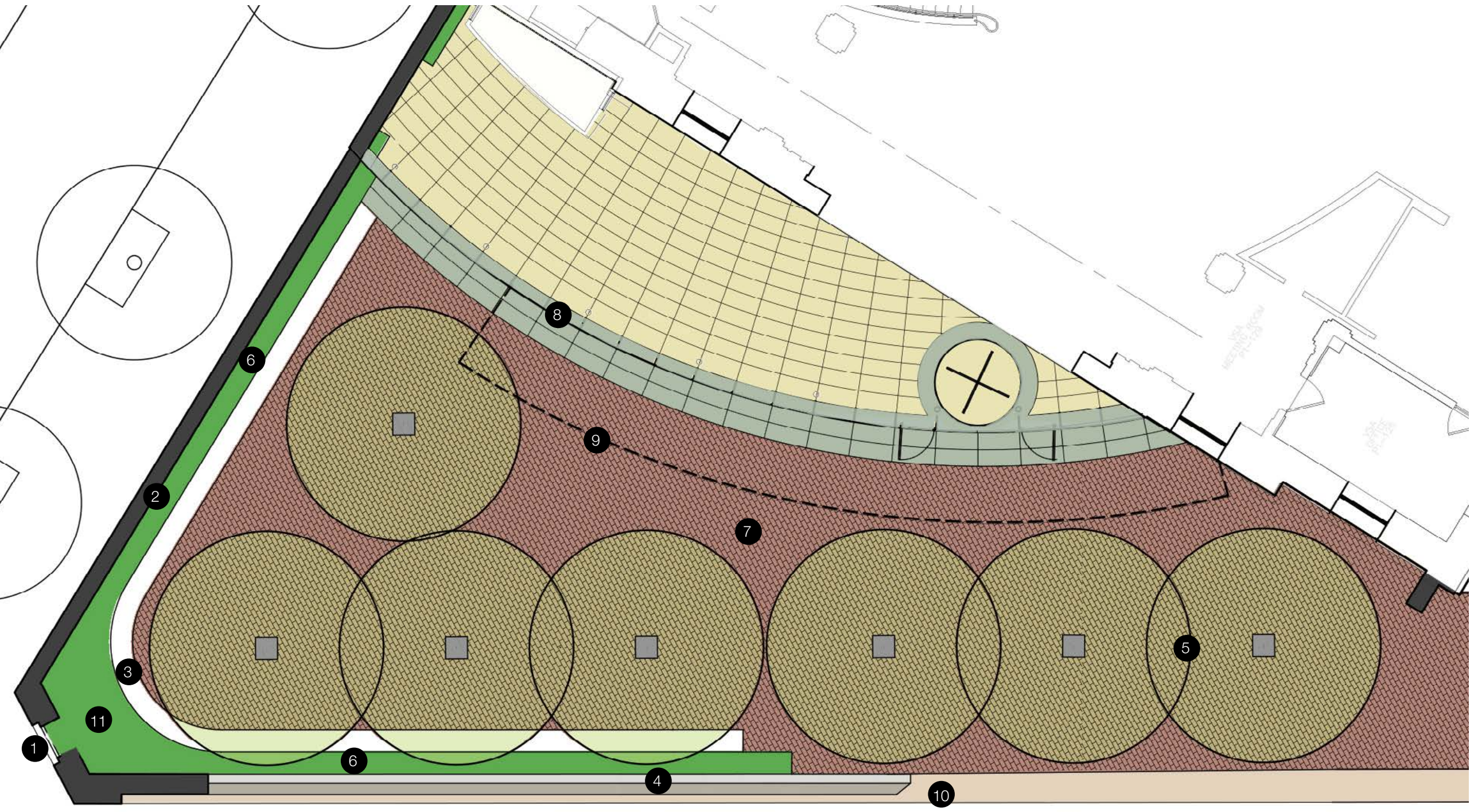

- 1 PROPOSED GLASS PANEL  
With Bead Blasted S.S. Frame
- 2 RELOCATED GREEN GRANITE QUOTE
- 3 WOOD & STAINLESS STEEL SEAT WALL  
(With Integrated Feature Lighting)
- 4 PROPOSED GLASS WALL  
With Bead Blasted S.S. Frame
- 5 PROPOSED SHADE TREE  
4.5 Cal. with flush inground uplight, canopy  
mounted moonlighting, Silvacell Root-Cell  
System and Irrigation/Aeration System
- 6 PROPOSED ENGLISH IVY COVERED WALL
- 7 PROPOSED BRICK PLAZA PAVING
- 8 EXISTING GLASS CURTAIN WALL
- 9 EXISTING OVERHEAD CANOPY
- 10 PROPOSED SIGNAGE - in development
- 11 PROPOSED PLANTING

BUS SHELTER



MASSACHUSETTS AVE. GARDEN ENTRANCE  
**EXISTING**





MASSACHUSETTS AVE. GARDEN ENTRANCE  
**PROPOSED**



- 1 PROPOSED GLASS PANEL  
With Bead Blasted S.S. Frame
- 2 RELOCATED GREEN GRANITE QUOTE
- 3 WOOD & STAINLESS STEEL SEAT WALL  
(With Integrated Feature Lighting)
- 4 PROPOSED GLASS WALL  
With Bead Blasted S.S. Frame
- 5 PROPOSED SHADE TREE  
4.5 Cal. with flush inground upright, canopy  
mounted moonlighting, Silvacell Root-Cell  
System and Irrigation/Aeration System
- 6 PROPOSED ENGLISH IVY COVERED WALL
- 7 PROPOSED BRICK PLAZA PAVING
- 8 EXISTING GLASS CURTAIN WALL
- 9 EXISTING OVERHEAD CANOPY
- 10 PROPOSED SIGNAGE - in development
- 11 PROPOSED PLANTING

MASSACHUSETTS AVE. GARDEN ENTRANCE  
**EXISTING**



EXISTING  
ARCH

MAPPARIUM  
Open 10 am-4 pm Tuesday-Sunday  
MARY BAKER EMMY  
Library

MASSACHUSETTS AVE. GARDEN ENTRANCE  
**PROPOSED**



- 1 PROPOSED GLASS PANEL  
With Bead Blasted S.S. Frame
- 2 RELOCATED GREEN GRANITE QUOTE
- 3 WOOD & STAINLESS STEEL SEAT WALL  
(With Integrated Feature Lighting)
- 4 PROPOSED GLASS WALL  
With Bead Blasted S.S. Frame
- 5 PROPOSED SHADE TREE  
4.5 Cal. with flush inground uplight, canopy  
mounted moonlighting, Silvacell Root-Cell  
System and Irrigation/Aeration System
- 6 PROPOSED ENGLISH IVY COVERED WALL
- 7 PROPOSED BRICK PLAZA PAVING
- 8 EXISTING GLASS CURTAIN WALL
- 9 EXISTING OVERHEAD CANOPY
- 10 PROPOSED SIGNAGE - in development
- 11 PROPOSED PLANTING

# MASSACHUSETTS AVE. GARDEN ENTRANCE LIGHTING LOCATIONS



MASSACHUSETTS AVE. GARDEN ENTRANCE  
**EXISTING**



MASSACHUSETTS AVE. GARDEN ENTRANCE  
**PROPOSED**



- 1 PROPOSED GLASS PANEL  
With Bead Blasted S.S. Frame
- 2 RELOCATED GREEN GRANITE QUOTE
- 3 WOOD & STAINLESS STEEL SEAT WALL  
(With Integrated Feature Lighting)
- 4 PROPOSED GLASS WALL  
With Bead Blasted S.S. Frame
- 5 PROPOSED SHADE TREE  
4.5 Cal. with flush inground uplight, canopy  
mounted moonlighting, Silvacell Root-Cell  
System and Irrigation/Aeration System
- 6 PROPOSED ENGLISH IVY COVERED WALL
- 7 PROPOSED BRICK PLAZA PAVING
- 8 EXISTING GLASS CURTAIN WALL
- 9 EXISTING OVERHEAD CANOPY
- 10 PROPOSED SIGNAGE - in development
- 11 PROPOSED PLANTING

MASSACHUSETTS AVE. GARDEN ENTRANCE  
**PROPOSED**

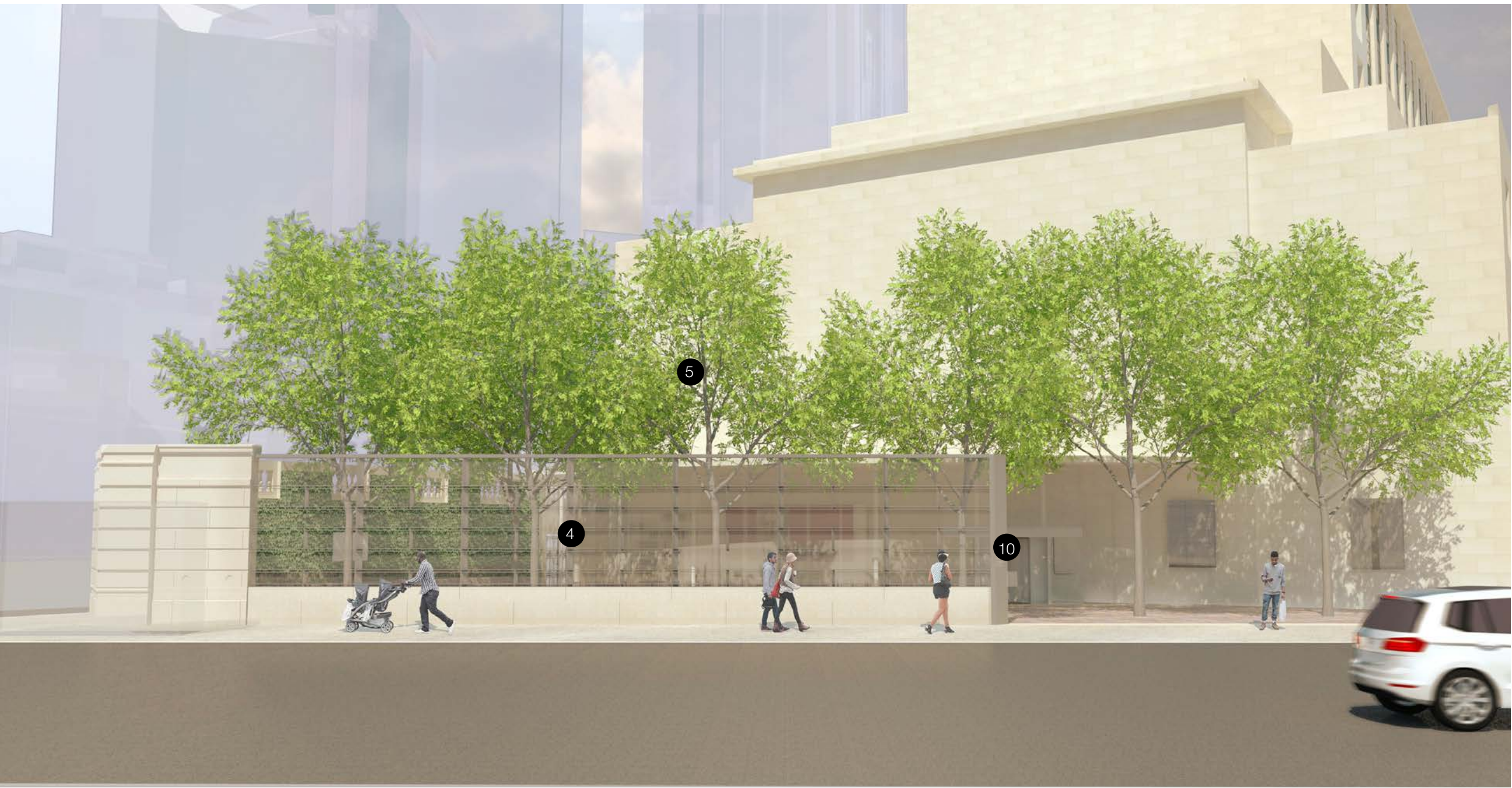

- 1 PROPOSED GLASS PANEL  
With Bead Blasted S.S. Frame
- 2 RELOCATED GREEN GRANITE QUOTE
- 3 WOOD & STAINLESS STEEL SEAT WALL  
(With Integrated Feature Lighting)
- 4 PROPOSED GLASS WALL  
With Bead Blasted S.S. Frame
- 5 PROPOSED SHADE TREE  
4.5 Cal. with flush inground uplight, canopy  
mounted moonlighting, Silvacell Root-Cell  
System and Irrigation/Aeration System
- 6 PROPOSED ENGLISH IVY COVERED WALL
- 7 PROPOSED BRICK PLAZA PAVING
- 8 EXISTING GLASS CURTAIN WALL
- 9 EXISTING OVERHEAD CANOPY
- 10 PROPOSED SIGNAGE - in development
- 11 PROPOSED PLANTING

MASSACHUSETTS AVE. GARDEN ENTRANCE  
**PROPOSED CLEARWAY / MASS. AVE. CORNER**



- 1 PROPOSED GLASS PANEL  
With Bead Blasted S.S. Frame
- 2 RELOCATED GREEN GRANITE QUOTE
- 3 WOOD & STAINLESS STEEL SEAT WALL  
(With Integrated Feature Lighting)
- 4 PROPOSED GLASS WALL  
With Bead Blasted S.S. Frame
- 5 PROPOSED SHADE TREE  
4.5 Cal. with flush inground upright, canopy  
mounted moonlighting, Silvacell Root-Cell  
System and Irrigation/Aeration System
- 6 PROPOSED ENGLISH IVY COVERED WALL
- 7 PROPOSED BRICK PLAZA PAVING
- 8 EXISTING GLASS CURTAIN WALL
- 9 EXISTING OVERHEAD CANOPY
- 10 PROPOSED SIGNAGE
- 11 PROPOSED PLANTING



# MASSACHUSETTS AVE. GARDEN ENTRANCE

## PROPOSED PLAN



- 1 PROPOSED GLASS PANEL  
With Bead Blasted S.S. Frame
- 2 RELOCATED GREEN GRANITE QUOTE
- 3 WOOD & STAINLESS STEEL SEAT WALL  
(With Integrated Feature Lighting)
- 4 PROPOSED GLASS WALL  
With Bead Blasted S.S. Frame
- 5 PROPOSED SHADE TREE  
4.5 Cal. with flush inground upright, canopy  
mounted moonlighting, Silvacell Root-Cell  
System and Irrigation/Aeration System
- 6 PROPOSED ENGLISH IVY COVERED WALL
- 7 PROPOSED BRICK PLAZA PAVING
- 8 EXISTING GLASS CURTAIN WALL
- 9 EXISTING OVERHEAD CANOPY
- 10 PROPOSED SIGNAGE
- 11 PROPOSED PLANTING

MASSACHUSETTS AVE. GARDEN ENTRANCE  
**SUNKEN GARDEN SEATWALL**

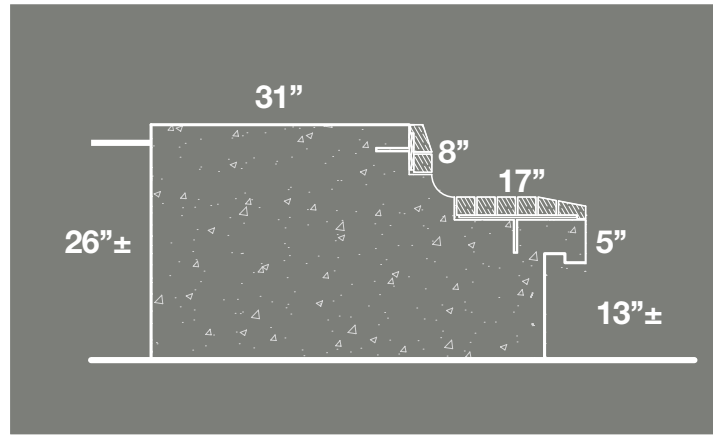

MASSACHUSETTS AVE. GARDEN ENTRANCE  
**TMCO INNER BENCH**

